

The Wreck of the Brig *Sultan*: An Archaeological Investigation

By

David M. VanZandt MMA, RPA,

Jim Paskert, Kevin Magee,

Chris Kraska, Ken Marshall,

and

Linda Pansing

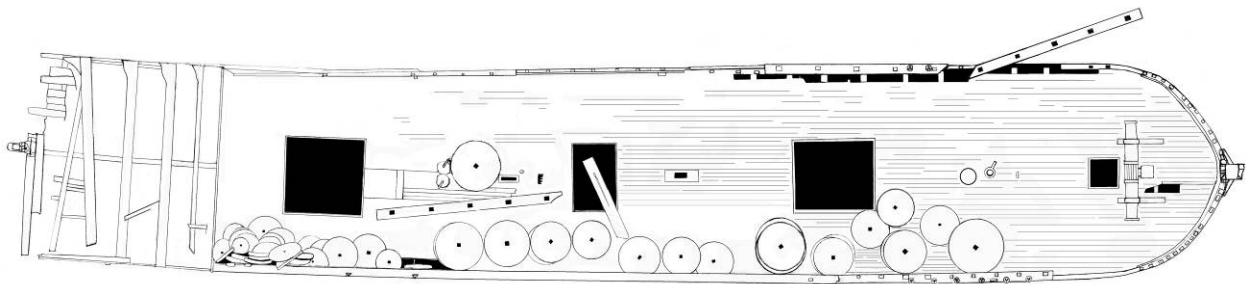

Brig Sultan

Maritime Archaeological Survey Team

February 2016

Table of Contents

1) Introduction	10
Discovery	10
Identification	12
Location	13
Disposition	14
2) Shipwreck Law	15
3) Mooring and Buoy Placement	16
4) A Brief History of the Brig Sultan.....	20
5) Environmental Setting	29
Bathymetry.....	29
Geology.....	34
Flora and Fauna.....	37
6) Survey Design.....	40
Objective.....	40
Survey Team Project Management Structure.....	40
Survey Methodology.....	41
Survey Training.....	46
Pre-dive Planning Aids	47
Dive Safety.....	51
7) Archaeological Documentation	53
Field Work.....	53

Sultan Survey Report

The Dive Site.....	59
Portable Artifacts.....	79
Deck Hardware.....	79
Ceramics and Pottery.....	85
Survey Results	88

Figures

Figure 1 <i>Sultan</i> side scan sonar image and reconnaissance survey sketch (Sidescan image by David VanZandt, CLUE, Sketch by Kevin Magee, CLUE)	10
Figure 2 <i>Sultan</i> reconnaissance survey photos (Photos by David VanZandt, CLUE).....	11
Figure 3 <i>Sultan</i> location off of Cleveland, Ohio (Ken Marshall and Mike Wachter, MAST).....	12
Figure 4 <i>Sultan</i> mooring block (Photo by David VanZandt, CLUE)	17
Figure 5 Mooring block and buoy configuration (Ken Marshall and Matthew Ballish, MAST)..	18
Figure 6 North American Great Lakes (Michigan Sea Grant).....	29
Figure 7 Bathymetric Map of Lake Erie (NOAA)	30
Figure 8 Bathymetric Map of the Central Basin of Lake Erie (NOAA)	31
Figure 9 Bathymetric Map of Area around <i>Sultan</i> (NOAA)	32
Figure 10 Sidescan Sonar of Area around <i>Sultan</i> (David VanZandt/CLUE)	33
Figure 11 Example Southwest-to-Northeast Geologic Cross Section, Lake Erie off Cleveland, Ohio (Dames and Moore).....	34
Figure 12 Near-Shore Sediment, Till, and Bedrock Summaries, Lake Erie off Cleveland, Ohio (U.S. Army Corp of Engineers).....	35
Figure 13 Vibracore Profile near <i>Sultan</i> , Lake Erie (U.S. Army Corp of Engineers)	36
Figure 14 Lake Erie Food Web (NOAA Great Lakes Environmental Research Laboratory)	37
Figure 15 Control point marker (Photo by David VanZandt, CLUE)	41
Figure 16 <i>Sultan</i> mud map (Sketch by Kevin Magee, CLUE).....	42
Figure 17 <i>Sultan</i> plan view (Kevin Magee, CLUE)	44
Figure 18 Primary control point network (David VanZandt, CLUE).....	44
Figure 19 Primary and secondary control point networks (David VanZandt, CLUE)	45
Figure 20 Sidescan sonar image with detail (CLUE).....	46

Figure 21 Survey measurement instruction aid (MAST)	47
Figure 22 Pre-dive Task List Example (MAST).....	48
Figure 23 Measurement recording sheet (MAST).....	49
Figure 24 Pre-dive survey technique briefing (Photo by Linda Pansing, MAST)	52
Figure 25 <i>Holiday</i> moored to <i>Sultan</i> buoy (Photo by Chris Kraska, MAST)	53
Figure 26 Survey diver ready to enter water (Photo by Linda Pansing, MAST)	54
Figure 27 Working survey diver (Photo by David VanZandt, CLUE)	55
Figure 28 Divers returning and checking in (Photo by Linda Pansing, MAST)	56
Figure 29 Diver transposing survey data from wet to dry notes (Photo by Linda Pansing, MAST) 57	
Figure 30 Silt-filled hold (Photo by David VanZandt, CLUE).....	58
Figure 31 Mussels (Photo by David VanZandt, CLUE).....	59
Figure 32 Bow with missing bowsprit (Photo by Chris Kraska, MAST)	60
Figure 33 Wood-stock bower anchor, port side (Photo by Chris Kraska, MAST).....	61
Figure 34 Metal stream or small bower anchor with attached cathead, starboard side (Photo by David VanZandt, CLUE)	61
Figure 35 Bow and cutwater (Photo by Jack Papes, Akron, Ohio)	62
Figure 36 Bowsprit (Photo by David VanZandt, CLUE)	63
Figure 37 Windlass (Photo by David VanZandt, CLUE)	63
Figure 38 Bowsprit notch in bow (Photo by David VanZandt, CLUE)	64
Figure 39 Port anchor chain running to windlass (Photo by David VanZandt, CLUE)	64
Figure 40 Chain locker and broken anchor chain coming out of starboard spurling pipe (Photo by David VanZandt, CLUE)	65
Figure 41 Anchor chain on deck starboard of the windlass (Photo by David VanZandt, CLUE) .	65
Figure 42 Single-barrel hand pump (Photo David VanZandt, CLUE)	66

Figure 43 Pump and foremast remains (Photo by David VanZandt, CLUE)	67
Figure 44 Chain plates and deadeyes (Photo by David VanZandt, CLUE).....	67
Figure 45 Intact starboard railing. (Photo by Jack Papes, Akron, Ohio).....	68
Figure 46 Intact port railing. (Photo by David VanZandt, CLUE)	69
Figure 47 Grindstones along starboard side near bow (Photo by David VanZandt, CLUE).....	69
Figure 48 Grindstones along starboard side (Photo by David VanZandt, CLUE)	70
Figure 49 Forward cargo hatch (Photo David VanZandt, CLUE)	71
Figure 50 Small center hatch (Photo by David VanZandt, CLUE)	71
Figure 51 Aft center board slot (Photo by David VanZandt, CLUE)	72
Figure 52 Two-barreled wooden pump and grindstone (Photo by David VanZandt, CLUE)	73
Figure 53 Dis-articulated deadeye on deck (Photo by David VanZandt, CLUE).....	73
Figure 54 Attached deadeye (Photo by David VanZandt, CLUE).....	74
Figure 55 Aft hatch (Photo by David VanZandt, CLUE)	74
Figure 56 Aft cabin combing (Photo by David VanZandt, CLUE)	75
Figure 57 Grindstones piled up at cabin combing interface (Photo by David VanZandt, CLUE)	76
Figure 58 Cabin floor joist (Photo David VanZandt, CLUE).....	76
Figure 59 Rudder post (Photo by David VanZandt, CLUE).....	77
Figure 60 Rudder post cap (Photo by David VanZandt, CLUE)	78
Figure 61 Broken ship's wheel (Photo by David VanZandt, CLUE).....	79
Figure 62 Ships stove in aft cabin space (Jack Papes, Akron, Ohio)	79
Figure 63 Possible stove part (Photo by David VanZandt, CLUE)	80
Figure 64 Possible mechanical cross-head near the two-barreled pump (Photo by David VanZandt, CLUE).....	80

Figure 65 Misc. deck hardware aft of main mast stub (Photo by David VanZandt, CLUE).....	81
Figure 66 Misc. deck hardware (Photo by David VanZandt, CLUE).....	81
Figure 67 Misc. chain and deck hardware, possible piece of the starboard cathead (Photo by David VanZandt, CLUE)	82
Figure 68 Double-pump mounting rings (Photo by David VanZandt, CLUE)	82
Figure 69 Metal clamp or vise (Photo by David VanZandt, CLUE)	83
Figure 70 Dis-articulated chain on deck (Photo by David VanZandt, CLUE)	83
Figure 71 Metal clamp located off of the bow (Photo by David VanZandt, CLUE).....	84
Figure 72 Anthony Shaw Cup (Photos by Chris Kraska, MAST).....	84
Figure 73 Ceramic sherd with presumed British diamond mark (Photos by David VanZandt, CLUE)	85
Figure 74 Representative British diamond mark (Thepotteries.org)	85
Figure 75 Various ceramics and pottery (Photos by David VanZandt, CLUE)	86
Figure 76 Various ceramics, pottery, and glass (Photos by David VanZandt, CLUE)	86
Figure 77 Example of filled in dry survey sheet (MAST).....	88
Figure 78 Site Recorder data validity check for early survey data from the <i>Sultan</i> (David VanZandt, CLUE).....	89
Figure 79 <i>Sultan</i> windlass (David VanZandt, CLUE)	89
Figure 80 <i>Sultan</i> master site plan (Chris Kraska, MAST).....	91
Figure 81 <i>Sultan</i> 360 Sonar 120 ft composite image. (Brian Abbott, Nautilus Marine Group International, LLC).....	92
Figure 82 <i>Sultan</i> 360 Sonar 90 ft composite image. (Brian Abbott, Nautilus Marine Group International, LLC).....	93

List of Tables

Table 1 *Sultan* Features Comparison12

1) **Introduction**

The Maritime Archaeological Survey Team Inc. (MAST) is a nonprofit avocational group dedicated to the documentation of Ohio's underwater historic resources. Formed in March of 2000, MAST is composed of volunteer individuals who support and participate in research, documentation, underwater archaeological surveys, and educational workshops. MAST's ongoing commitment to education includes training new members on skills and techniques used for shipwrecks research, measuring, mapping, and plotting. In addition, MAST works to educate our community in our historic underwater resources. MAST's shipwreck surveys have resulted in several technical reports for shipwrecks such as the *Adventure*, the *Hanna*, and the *F.H.Prince*. Additionally, these shipwrecks have been registered as official archaeological sites with the State of Ohio. MAST has also worked to produce underwater slates for the sites surveyed.

This report is the culmination of a project that evolved from an expressed desire of a local group of shipwreck enthusiasts to protect, preserve, and share one of their recent shipwreck discoveries. In late 2011 members of Cleveland Underwater Explorers Inc. (CLUE), a small non-profit organization of divers, historians, and archaeologists dedicated to researching, locating, exploring, and documenting shipwrecks and submerged cultural heritage in the Great Lakes, offered to share the location of the wreck of the brig *Sultan* contingent upon the local community's ability to fund the placement of an ongoing seasonal mooring at the wreck site. After careful consideration, MAST, with the assistance and support of CLUE, embarked on a fundraising campaign that raised enough money to not only place an ongoing seasonal mooring at the wreck site but also to finance a MAST-directed archaeological survey of the wreck, of which this report is the result. The following sections briefly describe the discovery and subsequent events that set the stage for the survey described and documented herein.

Discovery

Although the wreck of the *Sultan* was discovered by CLUE member Rob Ruetschle some years previous, a dedicated effort to explore, photograph, identify, and preliminarily survey the wreck was not undertaken until the summer of 2011. Figure 1 contains a high resolution side

scan sonar image and preliminary plan view developed after CLUE's first reconnaissance survey dives on 12 August 2011. Photographic and video images were gathered at the site, and several of these images are shown in Figure 2.

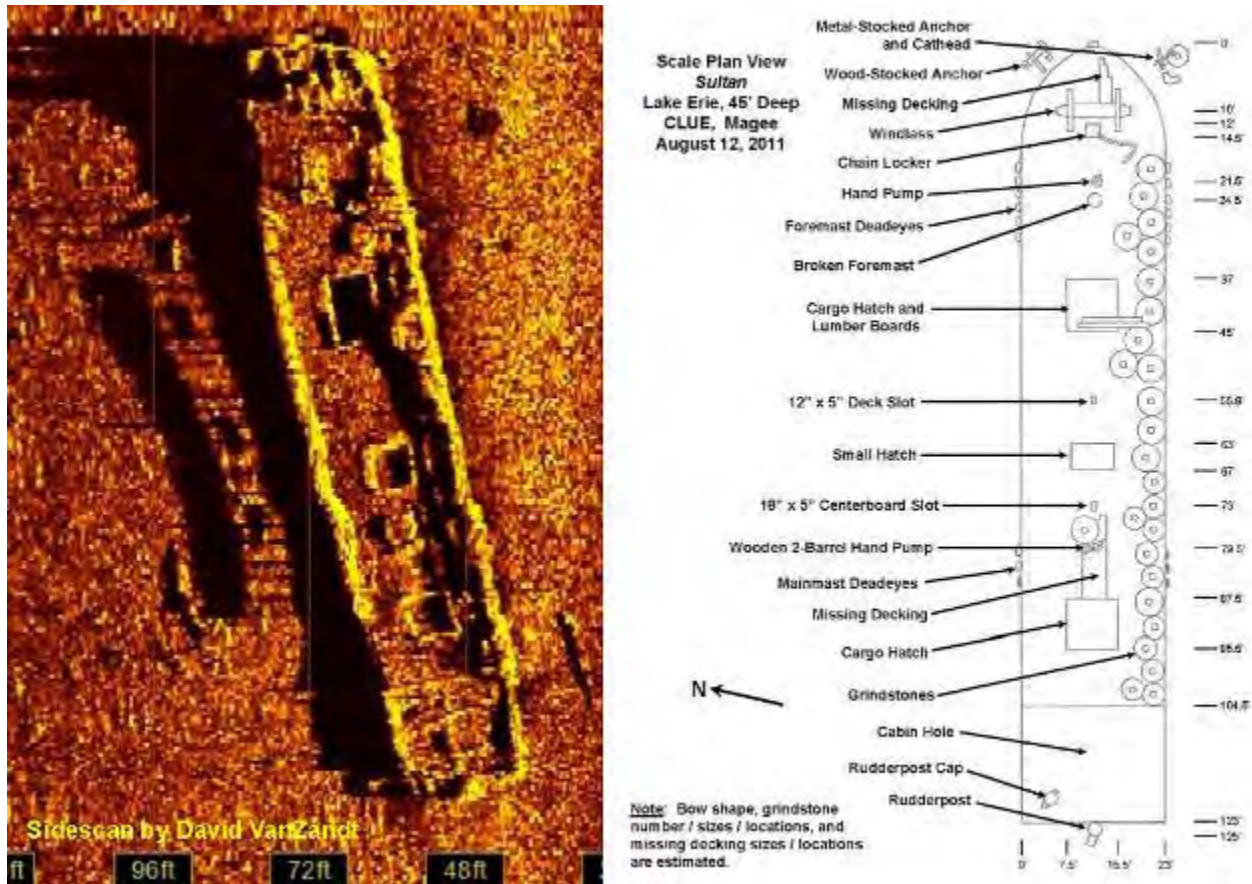

Figure 1 *Sultan* side scan sonar image and reconnaissance survey sketch (Sidescan image by David VanZandt, CLUE, Sketch by Kevin Magee, CLUE)



Figure 2 *Sultan* reconnaissance survey photos (Photos by David VanZandt, CLUE)

Identification

CLUE was able to gather and evaluate a sufficient amount of historical and archaeological data to confidently identify the wreck as the remains of the brig *Sultan*, lost with a cargo of grindstones in heavy weather shortly after leaving Cleveland, Ohio, for Buffalo, New York, on 24 September 1864 (VanZandt, 2009). Table 1 describes some of the features CLUE used to identify the wreck.

Category	Historic Value	Measured Value
Dimensions	127' x 24' x 9'4"	125' +0'/-6' x 23' +0'/-1'
Type of Vessel	2-masted brig	2-masted brig
Head Style	Billet	Billet
Cargo	Lumber, staves, and grindstones	Lumber and grindstones
Depth	36 feet (11 m)	42 feet (13 m)
Orientation	Partially on side with NW wind, downbound	Bow east, Starboard list
Location	Near Euclid, Ohio	Near Euclid, Ohio

Table 1 *Sultan* Features Comparison

Location

The *Sultan* is located in 45 feet of water off Euclid, OH, east of Cleveland at 41 deg 35.685 min N, 81 deg 36.936 min W, Figure 3.

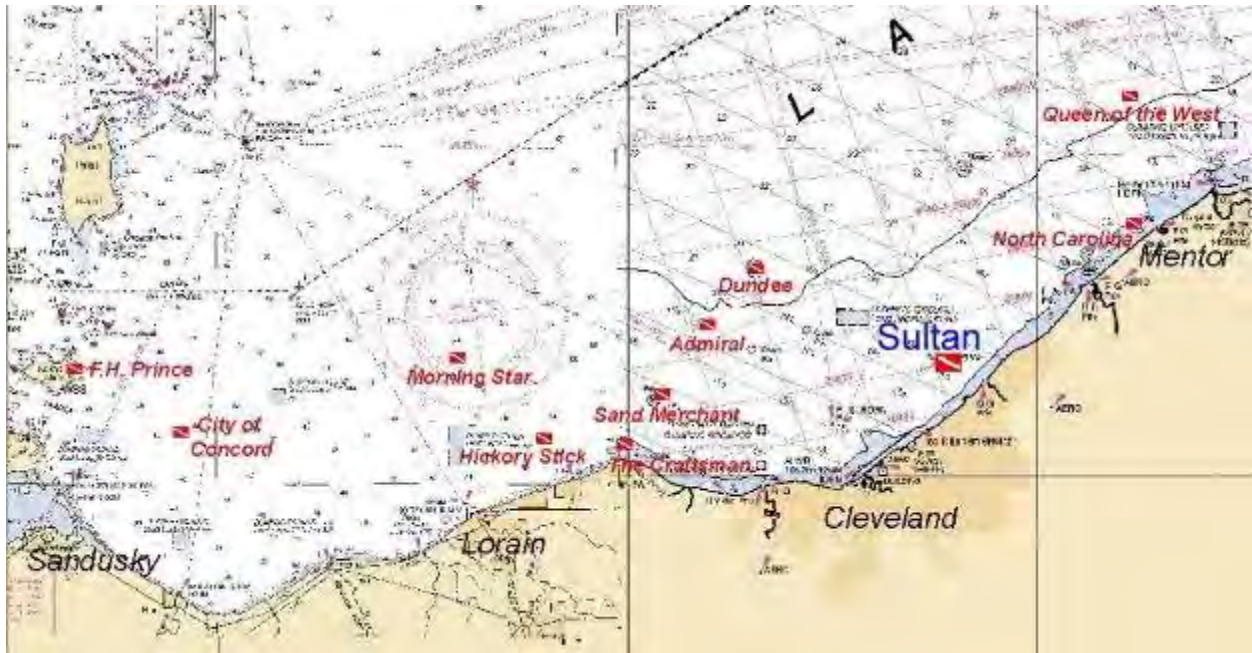

Figure 3 *Sultan* location off of Cleveland, Ohio (Ken Marshall and Mike Wachter, MAST)

Disposition

Struck by the relatively intact condition of the wreck, the shallowness of the water, and the better-than-average underwater visibility at the site, CLUE members quickly realized the wreck of the *Sultan* could provide an excellent diving and historical experience for novice and experienced shipwreck enthusiasts alike. The close proximity of the wreck to shore and harbor facilities had the potential to make the *Sultan* a top local diving destination. While compelled to share their discovery, CLUE members also recognized the potential for anchor damage from recreational and commercial boats. Ultimately - and as previously noted - CLUE committed to share the location of the wreck if the local diving community could raise sufficient funds to place an ongoing seasonal mooring at the wreck site.

Recognizing the opportunity to gain access and help preserve a very aesthetically pleasing, easily accessible, “as found” local shipwreck, MAST initiated the *Sultan* Mooring Buoy Project in the fall of 2011. CLUE assisted MAST with the project’s fund raising efforts through presentations at local dive shops and scuba shows throughout the winter of 2011-2012. Sufficient funds were raised to both properly install a mooring at the shipwreck site and perform the detailed archaeological survey.

The mooring was approved in late 2011 and installed in the late spring of 2012. The wreck was opened to the general diving public with a special charter to the wreck on 26 May 2012. The archaeological survey was performed by MAST divers over the summers of 2012 and 2013 under the direction of CLUE’s Director and Chief Archaeologist, David VanZandt.

2) **Shipwreck Law**

With the enactment of the Abandoned Shipwreck Act in 1987, the United States Congress stated that the United States holds title to abandoned shipwrecks in U.S. territorial waters (U.S. Code, 1987). The act then transferred title to States in which the shipwrecks rest, giving each State the responsibility to create laws to manage their own underwater resources (U.S. Code, 1987).

The Ohio legislature passed its management law (Ohio Revised Code Section 1506.30-1506.99) in 1992, and the law defines management “property” as any part of an abandoned sunken ship or aircraft, material from the ship or aircraft, and also includes Native American artifacts and features (Ohio Revised Code, 1992). The wreck of the *Sultan* is therefore the property of the State of Ohio and protected by state law. For this reason, all 2012-2013 MAST *Sultan* Survey participants were made familiar with the law and great care was taken not to disturb the wreck site.

The law allows for the removal of artifacts via a permit process that includes detailed application, review, and approval procedures. A permit was not needed for the 2012-2013 MAST *Sultan* Survey Project as no artifacts were to be removed.

During prior archaeological surveys conducted by MAST, permission was granted by the Ohio Department of Natural Resources and the Ohio Historic Preservation Office to remove zebra mussel encrustation in order to obtain detailed drawings and measurements. This survey, however, did not involve any such removal; and only visible sections of the wreckage were documented.

3) Mooring and Buoy Placement

The placement of a mooring was undertaken after the Cleveland Underwater Explorers offered to release the coordinates of the wreck once MAST had secured the requisite permits and funding for the endeavor. Protection of the wreck site and its cultural and historical value was the purpose of placing a permanent anchor block with a seasonal lighted buoy on the *Sultan* site. Together, the block and buoy 1) provide safe mooring for recreational dive vessels interested in diving the site, 2) ensure that the risk of dragging the site with an anchor and thereby causing significant and irreversible damage is minimized, and 3) add the site to the increasing number of moored shipwreck sites of historical significance currently maintained by the Maritime Archaeological Survey Team. With the addition of the *Sultan*, there are now eleven sites with moorings maintained by MAST.

The placement of moorings in the Ohio waters of Lake Erie involves multiple stakeholders including the requestor, in this case MAST, three governmental organizations, and one non-governmental organization (NGO) with a state charter division. The three governmental organizations include: the Ohio Department of Natural Resources – Office of Coastal Management (ODNR-OCM), the United States Army Corps of Engineers (USACE), and the United States Coast Guard (USCG). The NGO is the Ohio Historical Society – Ohio Historic Preservation Office (OHS-OHPO).

MAST presented the mooring plan to the ODNR-OCM who, after discussion/review, issued a statement of “consistency” indicating that the mooring was consistent with the state’s plan that requires underwater resources to be accessible to divers. Next, the mooring plan was submitted to the OHS-OHPO, who confirmed the ODNR-OCM “consistency,” discussed the placement of the anchor block, and considered Section 106 Historic Preservation Act impacts. After review, OHPO Deputy Director Franco Ruffini issued a letter of approval indicating that the anchor block could be placed at the site provided no artifacts would be damaged in the process. Third, the mooring plan, including the ODNR-OCM consistency statement and OHPO letter, was submitted to the USACE. After review, the USACE issued a Letter of Authorization

(LoA) approving the anchor block under Nation Wide Permit (NPW) #10, the same permit used for USCG buoy anchor blocks. Finally, the mooring plan was submitted to the USCG in the form of a permit application.

The open waters of Lake Erie are a navigable waterway and a border with the nation of Canada. These factors make the placement of a seasonal mooring buoy a Private Aid to Navigation (PATN) under the purview of the United States Coast Guard (USCG). The USCG had previously reviewed the MAST mooring plan and added a few requirements, including that the MAST mooring buoys utilize a lighted strobe for night-time visibility. After updating the mooring design to incorporate the USCG changes, permits have been issued for all requested moorings, including the *Sultan* mooring permit which was issued in December 2011.

A MAST mooring (Figure 5) costs about \$5000 to install and \$200/year to operate/maintain. The \$5000 cost includes \$500 for the 6000 pound anchor block and delivery of same, \$750 for the buoy, strobe, and hardware to attach it to the anchor block, \$750 for volunteer labor/materials to make and assemble custom/special parts that cannot be purchased, and \$3000 for the commercial diver and crane boat to set the anchor block. The commercial placement uses underwater communications gear to be sure the block is spotted as close as possible to the desired spot without damaging the site.

The 6000 lb anchor blocks are purchased from Norwalk Concrete Industries (NCI) and transported by NCI to the Underwater Marine Contractors (UMC) dock. Mooring hardware from Samsel Supply (marine supplier) is attached to the blocks by MAST volunteers. MAST members place a temporary float adjacent to the shipwreck to mark the approximate location for the placement of permanent anchor block. The marine contractor (UMC) transports the block to the shipwreck site and places it in the designated area adjacent to the shipwreck (Figure 4). Later, MAST members attach the remainder of the seasonal buoy hardware (solar lighted buoys, ballast chain and polypropylene line) to the mooring. The seasonal portion above the underwater float is removed in October, inspected/serviced, and re-installed in May.

The boating public is notified of the mooring locations through the USCG Light List and changes in conditions through the USCG Notice to Mariners (NOTAM) system. Donations and

grants have covered all costs for the mooring program to date with the local scuba community actively supporting the project.

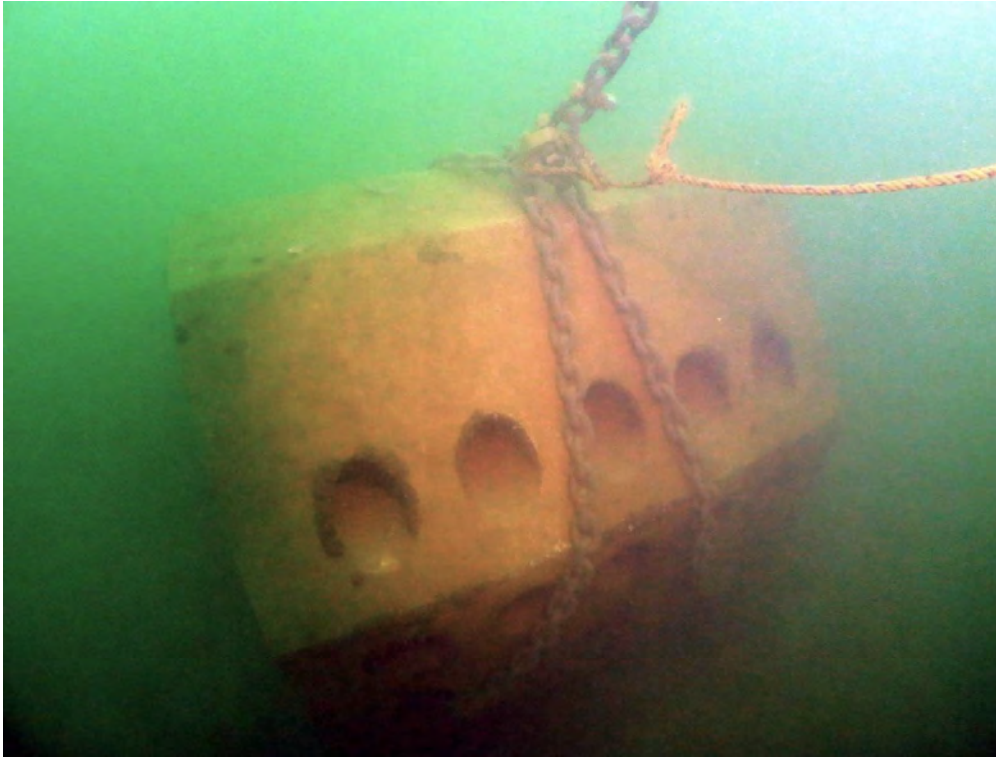

Figure 4 *Sultan* mooring block (Photo by David VanZandt, CLUE)

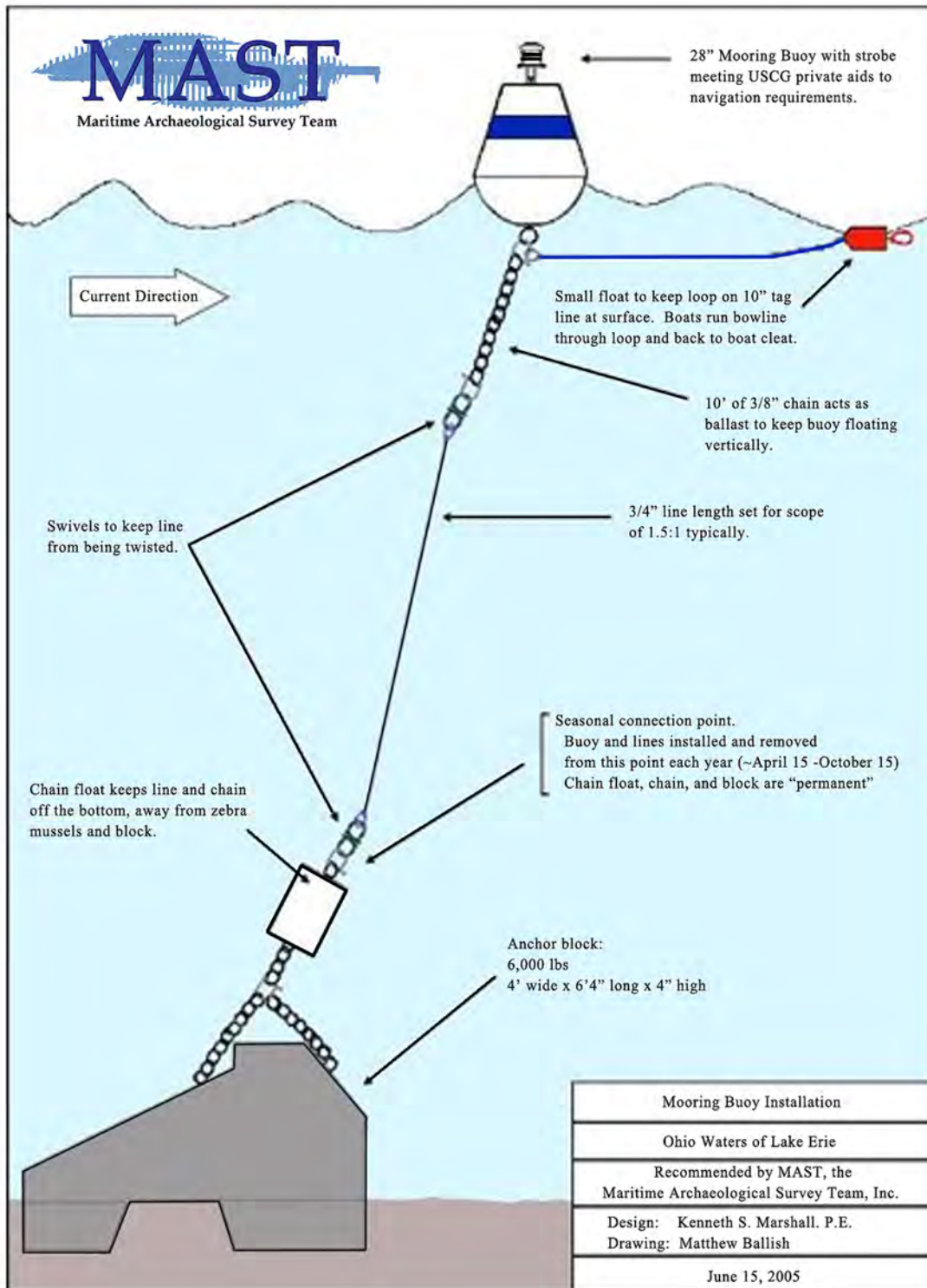

Figure 5 Mooring block and buoy configuration (Ken Marshall and Matthew Ballish, MAST)

4) **A Brief History of the Brig *Sultan***

The brig *Sultan* was built by James Averill at Chicago in 1848. Averill, a shipbuilder from Maine (Mansfield 1899, p 404), had established a shipyard there in 1842 most likely to take advantage of the increased interest in investment in lake shipping occurring at the time. Prior to 1842 only a handful of vessels had been built at Chicago and the Averill shipyard, located just below the Rush Street Bridge (Andreas 1884, p 242), became Chicago's third active shipbuilding operation when it opened. A total of fifteen new vessels were constructed at Chicago from 1843 through 1846 and Chicago became a Port of Entry in 1846 as well. Shipbuilding activity increased dramatically in 1847 and an additional fifteen new vessels were enrolled there that year including the Averill-built brig S.F. Gale (District of Chicago 1847). The *Sultan* was completed in April 1848 but not enrolled until 27 July 1848 (District of Chicago 1848a) suggesting that Averill built the *Sultan* on speculation and required some additional time to solicit interested investment partners. Averill along with George M. Higginson, George M. Dole, George Rumsey and Julian L. Rumsey, all of Chicago, are listed as the owners of the *Sultan* on the first enrollment (District of Chicago 1848a) and, just three months later, Averill sold his interest in the vessel to the others (District of Chicago 1848b).

Constructed of oak and measuring 127 feet in length, 24 feet in breadth, 9 feet 4-5/8 inches in depth and 267-00/95 tons, the *Sultan* had one deck, two masts, no gallery and a billet head (District of Chicago 1848a). The *Sultan* appears to be very similar in detail to the brig S.F. Gale built and launched almost exactly one year previous by Averill in April 1847 as noted previously. The S.F. Gale measured 122 feet 6 inches in length, 24 feet in breadth, 9 feet 9 inches in depth, 266-24/95 tons with one deck, two masts, no gallery and a scroll head (District of Chicago 1847). In November 1876 the S.F. Gale was lost with all hands in a gale on Lake Erie twenty miles NW of Cleveland after a long and prosperous career.

Originally constructed for and employed in the lumber trade, the *Sultan*, like most sailing vessels hailing from western Lake Michigan ports, also found work hauling grain. Lumber and

grain cargos were typically delivered to lower lake ports such as Buffalo where cargos of coal or manufactured goods were usually available for the return trip to Lake Michigan.

The *Sultan* was owned and operated out of Chicago from the time of its construction in 1848 until May of 1854 when it was sold to H. C. Walker & Co. of Buffalo, New York, who had the brig completely refitted (Maritime History of the Great Lakes 2013a). These repairs were necessitated by the last of several unfortunate accidents which occurred during the 1853 shipping season. On 6 June 1853 the *Sultan* capsized and sank five miles from Chambers Island, Green Bay, Lake Michigan. The wreck was successfully raised in early July 1853 (Maritime History of the Great Lakes 2013b), repaired at Chicago during August and September, and returned to service (Maritime History of the Great Lakes 2013c). Just two months later, on 11 November 1853, the *Sultan*, loaded with a cargo of railroad iron intended for the Galena Railroad, went ashore and was heavily damaged at Forty Mile Point, Lake Huron. Salvors were successful in salvaging the cargo of railroad iron, which was then sent to Chicago, but due to the lateness of the season, the *Sultan* was left to endure the winter of 1853-1854 in the shallow waters near Forty Mile Point. Efforts to salvage the *Sultan* were renewed the following spring, and it was pumped out and released (Maritime History of the Great Lakes 2013a).

An additional incident occurred on 4 November 1856 when the *Sultan*, loaded with a cargo of wheat, went ashore on the east side of Lake Huron about fifty miles above Goderich, Ontario, near old Port Bruce, Ontario, Canada. The cargo of wheat was lightered off, and the brig was released and subsequently taken to Detroit, Michigan, where it was repaired later that same month (Maritime History of the Great Lakes 2013d). The *Sultan* was purchased by Robert Mills of Buffalo in April of 1858 (District of Buffalo 1858) and continued in the lumber and grain trade until April of 1859 when Mills sold the brig to the mercantile firm of Dibble & Co. of New York, New York (District of Buffalo 1859). On 2 June 1859 the *Sultan* sailed from Buffalo to the city of New York via the Welland Canal and St. Lawrence River. On 5 November 1859 the *Sultan* was registered at the Port of New York (District of Buffalo 1859) and commenced an interesting two-year saltwater career trading between New York and various ports in North and South Carolina.

Calvin B. Dibble, a successful merchant, owned and controlled the mercantile firm of Dibble & Co. with headquarters in New York, New York, and branches in several North and South Carolina port towns. Dibble was a native of Hartford, Connecticut and maintained his home there. He also owned property in North Carolina and in the early 1840's owned and operated a river steamboat in Newbern, North Carolina. It appears that Dibble owned one or two other vessels that were used to trade between New York and the southern states. It is assumed that an increase in demand stimulated Dibble to purchase an additional vessel. Exactly why Dibble purchased an inland, freshwater vessel is not clear.

The *Sultan* made regular trips between New York, New York, and Georgetown, South Carolina (The New York Times 1860a:8, 1860b:8, 1860c:8, 1861a:8). The nature of the cargos loaded in New York and freighted to Georgetown is not known. Entry records for freight loaded in Georgetown and landed in New York consistently describe these cargos as "naval stores" (The New York Times 1860b:8, 1861a:8). The definition of "naval stores" has yet to be determined. Upon the commencement of the Civil War in 1861, Dibble apparently used his various long-established connections with many high ranking U.S. military officers to receive permission to continue to conduct trade between New York and several southern coastal ports still under the control of the U.S. military (Dibble 1864:14-16).

In late August 1861 the *Sultan* sailed in ballast from Havana, Cuba, to New York City under the command of Captain Sutton (The New York Times 1861b:8). Captain Sutton had been the master of the *Sultan* during its entire saltwater career. Exactly why the *Sultan* was in Havana and departed with no cargo is still unknown. On 9 September Mrs. Sutton, the brig's cook and the wife of Captain Sutton, died and was buried at sea. The *Sultan* arrived in New York City on 11 September and was "anchored in the Lower Quarantine" as reported in the 'Marine Intelligence' column in The New York Times (The New York Times 1861b). Just over three weeks later, on 4 October 1861, the *Sultan*, under the command of Captain Sutton, cleared New York for Chicago, Illinois (The New York Times 1861c:8), thus ending its saltwater career.

No doubt the death of Mrs. Sutton and possibly the cause of her death (e.g. cholera), along with other factors, influenced Dibble to sell the vessel quickly. The brig's recent history might have made it difficult to secure a crew and/or sell the vessel locally. It may have been

much easier and more profitable to return the vessel to the Great Lakes where interested parties may not be as well informed. This, of course, is purely speculation.

Interestingly, Dibble continued to trade between New York and South Carolina ports until he was suspected of aiding the enemy when one of his schooners ran aground in a remote area and the entire cargo was seized by Confederate forces. The U.S. government investigated and suspected that Dibble had arranged to have the vessel purposely run ashore as a ruse. He was never charged with a crime, however, but did lose his trading rights and was forced to turn over his property in the South to the U.S. government. It does appear that Dibble was a loyal citizen and there is no hard evidence of any wrong doing. The fact that he had lived in the South for some time and had many connections there coupled with the fact that he hailed from Hartford, Connecticut, the epicenter of U.S. arms manufacturing, and was well connected there as well, was enough to make him suspect. There is the possibility, however remote, that the brig *Sultan* was used to smuggle various goods and possibly arms to the Confederates.

Dibble & Co. ultimately sold the *Sultan* in June of 1862 to Thatcher, Burt & Co., merchants located in Cleveland, Ohio (District of Cuyahoga 1862), who had the brig completely rebuilt in December by Cleveland shipbuilder Foote & Keating (The Cleveland Leader 1864:4). Thatcher, Burt & Co. owned and operated the *Sultan* until the time of its final loss.

It is important to note that the last enrollment issued to the *Sultan*, No. 62, dated 28 June 1862 (District of Cuyahoga 1862), states the breadth of the vessel to be 28 feet, which conflicts with the breadth of 24 feet indicated on all of the *Sultan's* previous enrollments. This same document certifies the tonnage as 267-00/95, which is unchanged from all of the previous enrollments. The tonnage could not remain the same if the breadth of the vessel was altered. The breadth on the last enrollment appears to be incorrect and is undoubtedly a transcription error which occurred when the information was copied from the previous enrollment.

The seas were running high when the tug Ajax towed the *Sultan* out of Cleveland at 1:00 P.M. on Saturday, 24 September 1864 (The Cleveland Leader 1864:4). The crew of eight consisted of newly appointed Captain Nelson Webster of Fairport, Ohio, First Mate Eleazor Spear of Kirtland, Ohio, Second Mate and brother of the Captain Douglas Webster of Fairport, Ohio, Steward Christopher Roe of Euclid, Ohio, Seaman James Greer of Dunnville, C.W.

[Ontario, Canada], Seaman Stephen Johnson of Fairport, Ohio, Seaman Monroe Ellsworth of Fairport, Ohio, and Seaman Barney Carroll of Dunnville, C.W. [Ontario, Canada] (The Cleveland Leader 1864:4). The brig was bound for Buffalo, New York, with a cargo of 200 tons of grindstones shipped by J. McDermott & Co., Wilson, Crittenden & Co. and B. Clough along with some hickory lumber and a small quantity of staves (The Cleveland Herald 1864:3). The grindstones came from the Amherst and Berea, Ohio areas, both well known for the quality of their stone, and many of the larger grindstones were stacked on the deck rather than in the cargo hold.

Prior to departing Captain Webster was advised by more than a few people including George W. Gardner, one of the principals in the firm of Thatcher, Burt & Co., owner of the *Sultan*, that he should stay in port as the seas were too high to risk making the trip at that time. Some years later Mr. Gardner would recall:

“We had just appointed a young fellow to captain and I called him aside and told him that the trip was not a matter of life and death and he had better wait until the storm abated. He was ambitious, however, to make a record and insisted upon going out, saying that he could land the cargo in Buffalo easily on Monday morning” (Marine Review 1901:17).

The crew had the pleasure of having four ladies aboard the *Sultan* on the upbound trip from Buffalo, and the wives of Captain Webster and Steward Christopher Roe were aboard while the *Sultan* was docked in Cleveland. The wives left by train for their homes prior to the *Sultan's* departure (The Cleveland Leader 1864:4).

As the *Sultan* passed out of the Cuyahoga River and into the open waters of Lake Erie, the heavy seas began to lift and drop the brig more and more. As predicted by those who had warned Captain Webster to stay in port, the *Sultan* struck bottom on the bar near the mouth of the river and “pounded it very heavily five or six times” (The Cleveland Leader 1864:4). When the brig was well out into the lake, the towline was cast off, the sails were set, and the crew manned the pumps to determine if any damage had been sustained. No more water than usual was found in the bilge, and it appeared that no damage had been done (The Cleveland Leader 1864:4).

Not long afterward, the *Sultan* began “laboring heavily, the waves dashing over her” (The Cleveland Leader 1864:4). Working its way down the lake and well heeled over in the high wind

and seas, the *Sultan* made little progress. The order was soon given to start throwing a portion of the deck load of grindstones overboard “for the purpose of easing her” (The Plain Dealer 1864:3). At the same time, one of the crew entered the forecabin and discovered that the brig was leaking badly. The pumps were manned, but it soon became obvious that the brig was settling so Captain Webster ordered the *Sultan* put about in an attempt to run the brig onto the beach (The Plain Dealer 1864:3).

After sailing and drifting down the lake about two miles, the *Sultan* lurched and rolled on its side. The waves knocked off the cabin, and the deck load of grindstones shifted to the starboard side as staves, hickory timber, and cabin contents - including the trunks of the crew - were pitched into the lake. The *Sultan* was surrounded by wave-tossed debris that was “beating about the waves as if a ‘school’ of whales had been there pounding and ‘thrashing’ the sea for a meal” (The Cleveland Leader 1864:4).

The *Sultan* was now off Euclid, Ohio eight miles below Cleveland and about three miles from shore. Recognizing that the shifted deck load made it impossible for the *Sultan* to right itself, the crew realized the brig would soon be on the bottom. The small boat was cut loose but quickly filled with water. After ten minutes of futile bailing, First Mate Eleazor Speer abandoned any hope of using the small boat for rescue (The Cleveland Leader 1864:4). He then jumped onto the bulwarks and joined others of the crew as they began climbing the rigging with the *Sultan* settling fast beneath them. Seamen Monroe Elsworth and Barney Carroll, however, jumped into the nearly-filled small boat and drifted away in the high seas (The Cleveland Leader 1864:4). The last time anyone saw Elsworth and Carroll they were standing up in the small boat about half way between the wreck and shore (The Plain Dealer 1864:3).

When the *Sultan* struck bottom, First Mate Speer, Captain Webster, Second Mate Webster, and Seaman Johnson were clinging to the main top gallant mast while Seaman Greer and Steward Roe were similarly perched on the fore top gallant mast (The Plain Dealer 1864:3). With the *Sultan* resting on the bottom on its beam ends and swaying back and forth with the surge of every passing wave, the positions of the crew were very precarious. As the masts swayed back and forth, the jerking motion made clinging to the rigging “next to impossible” (The Cleveland Leader 1864:4). It was now 3:30 P.M.

Seaman Johnson decided to abandon his position on the main top gallant mast and join Steward Roe and Seaman Greer on the fore top gallant mast where they planned to cut the yard loose and use it to float to shore (The Cleveland Leader 1864:4). Johnson made the difficult swim to the foremast and stopped there to rest for a moment. Suddenly the mast broke, and Johnson, Roe, and Greer were all cast into the surging lake (The Cleveland Leader 1864:4). The exhausted Johnson sank immediately, but Roe and Greer were able to swim to the main-mast and take refuge there. Just over an hour later, with darkness setting in, a large wave wrenched the main-mast from its step throwing Roe and Greer into the lake never to be seen again (The Cleveland Leader 1864:4). The remaining three crew members, Captain Nelson Webster, his brother, Second Mate Douglas Webster, and First Mate Eleazor Spear, now found their situation even more difficult. Un-stepped, the mast swayed and jerked much worse than before with each passing wave. Spear was on top of the top gallant with Captain Webster located just below him and Second Mate Webster just below the Captain. Separated by only a few feet, they had to shout to hear one another over the crashing waves and howling wind (The Cleveland Leader 1864:4).

At approximately 9:00 P.M. Captain Webster realized his brother, Second Mate Douglas Spear, had fallen from or was washed off the main-mast and into the lake (The Cleveland Leader 1864:4). In the darkness the Captain called to his brother but received no reply. He shouted to Spear, "Doug is gone. Doug is gone. Do you see him? Can you see him?" (The Cleveland Leader 1864:4). Soon the rain stopped, and the sky cleared. The Captain and Mate talked about rescue with the Captain commenting about what his wife might think if she knew of his predicament and that he was glad she did not know (The Cleveland Herald 1864:3). Some hours later Spear heard a splash and called out to the Captain but received no reply. The Captain was gone, and Spear believed that he either fell asleep and fell from the mast or was so exhausted that he could no longer hold on (The Cleveland Herald 1864:3). Either way, First Mate Eleazor Spear was alone and the last of the eight man crew aboard what was now the wreck of the brig *Sultan*.

Spear slid down the mast to the place that had been occupied by Captain Webster since the swaying of the mast was less dramatic there. Fearing that he would succumb to the same fate as his fellow crew members, Spear used a piece of 'hamberline' that he had in his pocket to make two loops for his feet. He then secured it to the rigging making it easier to stand and hold onto

the swaying mast (The Cleveland Leader 1864:4). During the coming hours he would shift his weight periodically from one foot to the other in an attempt to avoid fatigue. It seemed like dawn would never come as Spear continued to hang on and hope (The Cleveland Herald 1864:3).

When dawn did come, Spear could see shore clearly, and he waved his hat to let people on shore know that there was someone still aboard the wrecked brig (The Cleveland Leader 1864:4).

George Gardner of Thatcher, Burt & Co., owners of the *Sultan*, received news late Saturday afternoon that a vessel was “in distress” (Marine Review 1901:17) off Euclid and the crew was in the rigging. He immediately knew that it had to be the *Sultan* as only hours before he had advised Captain Webster not to make the trip to Buffalo until the weather improved. Mr. Gardner later recollected:

“I received word that a vessel was in distress off Euclid Creek and that the crew were lashed to the cross-trees. The vessel was rolling frightfully and the crew were being submerged half of the time. I made up my mind that that was our brig, the *Sultan*, and I went down to the river to see if I could get some one to go out to help her. The only steamer in was the Northwest. I asked the captain if he would go out but he was afraid he would get stuck on the bar and declined. There was one tug near the government pier and I asked the captain of her if he wouldn’t go out. He said that his insurance wasn’t high enough. I asked him how much more he wanted and when he said \$4000 I volunteered to get it and pay the premium on it and to go out with him. He then said that the sea was too high and he wouldn’t risk it. I had to wait then until 4 o’clock in the morning when the Detroit & Cleveland steamer came in. She stopped at the government pier, as was her custom then, to discharge freight. In a moment or two Capt. McKay came down on the dock. I related the circumstances to him. He didn’t wait for me to ask him to go out but said very quietly, ‘I’ll be ready to back out in three minutes.’ He then asked me if I had a sharp knife. I told him I would have one by the time the steamer reached the wreck. When we got to the wreck there was only one man lashed to the rigging left. The rest had drowned. The captain said ‘I am going to run her nose across her quarters, so you lean over and cut that man loose from the rigging. You’ll have to work quick for I shall have to back out at once to save myself from being crushed.’ Well, he sent her bow over the boat and we cut the man loose. He was unconscious but we had some brandy on board and soon revived him” (Marine Review 1901:17).

The above description of the rescue differs significantly from the newspaper accounts which were undoubtedly based on interviews with sole survivor Eleazor Spear. The Cleveland Leader stated the following:

“The North Star made a pass for him but missed. Then the City of Cleveland came up, her rail passing about three feet below the yard to which he was lashed. He sprang aboard nimbly, having perfect use of his limbs, not being at all benumbed by the exposure to waves and chilly air” (The Cleveland Leader 1864:4).

Perhaps the brandy influenced Spear’s recollection of the rescue during his interviews with the press just after the City of Cleveland docked in Cleveland. Perhaps an ambitious and newly appointed reporter, not unlike an ambitious and newly appointed Lake Captain, decided to stretch things a bit to make a name for himself by embellishing his story. Regardless, Spear was rescued at about 8:00 A.M. on Sunday morning thanks to the skill and courage of Captain George McKay, Master of the Steamer City of Cleveland. Just weeks later, in October of 1864, in recognition of and appreciation for this gallant act and others that preceded it, the citizens of Cleveland presented Captain McKay with a gold watch and chain “suitably inscribed” (Marine Review 1901:17). During the weeks that followed the sinking of the *Sultan*, most of the bodies of the lost crew members came ashore or were found floating in the lake. Thereafter, the brig *Sultan* quickly became a forgotten shipwreck like the hundreds of others on the bottom of Lake Erie.

5) **Environmental Setting**

Bathymetry

The wreck of the *Sultan* lies in Lake Erie, the southernmost of the five Great Lakes in North America. The Great Lakes are shown in Figure 6 along with their profiles and surface elevations as the flow of fresh water is traced from Lake Superior to the lower lakes and eventually out into the Atlantic Ocean through the St. Lawrence River (Michigan Sea Grant, 2014).

Lake Erie is the shallowest of the Great Lakes with an average depth of 62 feet (19 meters) and a maximum depth of 210 feet (64 meters) (NOAA, 2014a). It is also the smallest of the Great Lakes by volume (116 cubic miles, or 483 cubic km), although it is only the fourth smallest by surface area (9,910 square miles, or 25,655 square km) (NOAA, 2014a). The water retention or replacement time is 2.7 years, which is short compared to the 6 to 173 years of the other Great Lakes (NOAA, 2014a). An overall bathymetric view of Lake Erie is shown in Figure 7 (NOAA, 2014c).

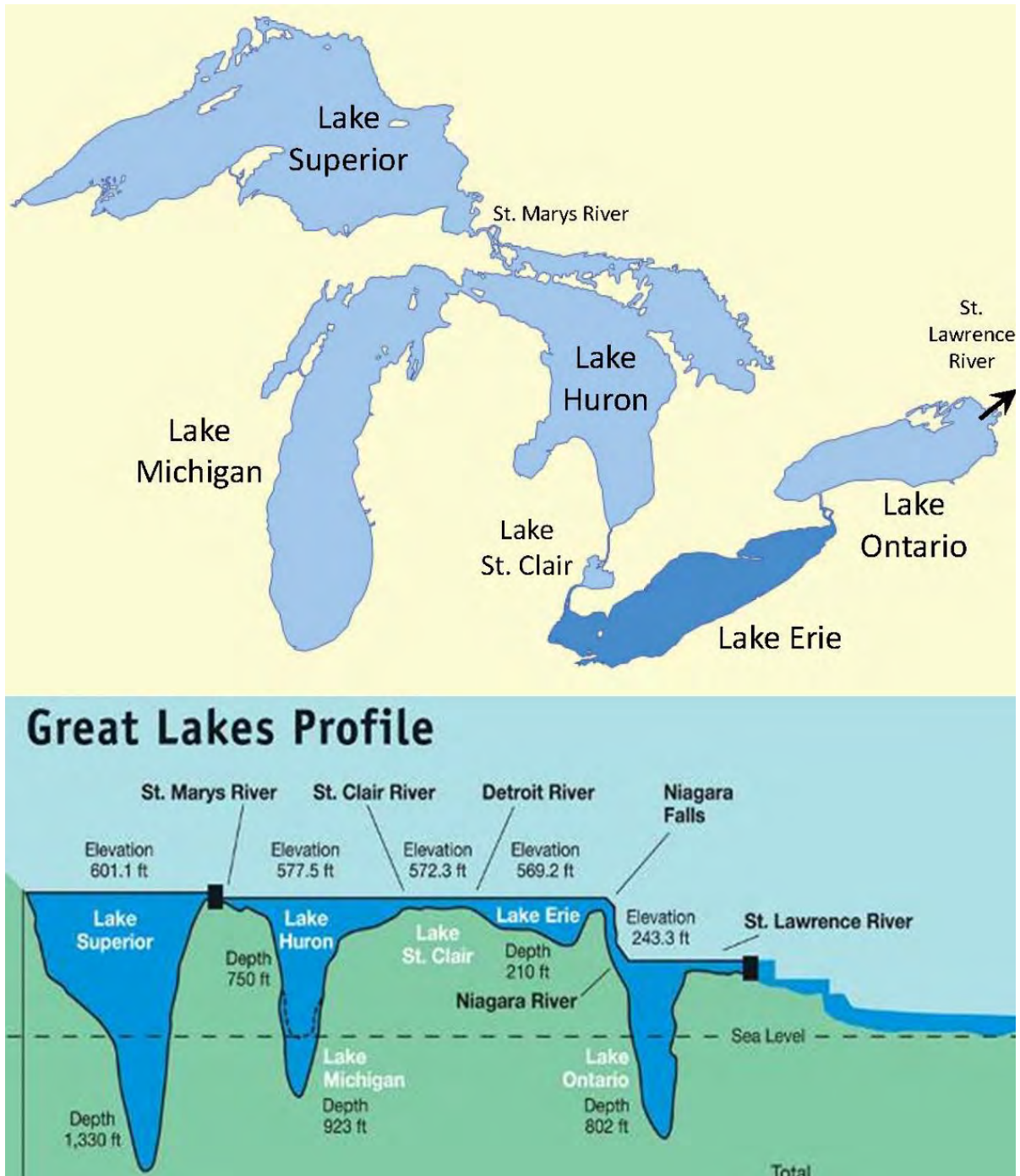

Figure 6 North American Great Lakes (Michigan Sea Grant)

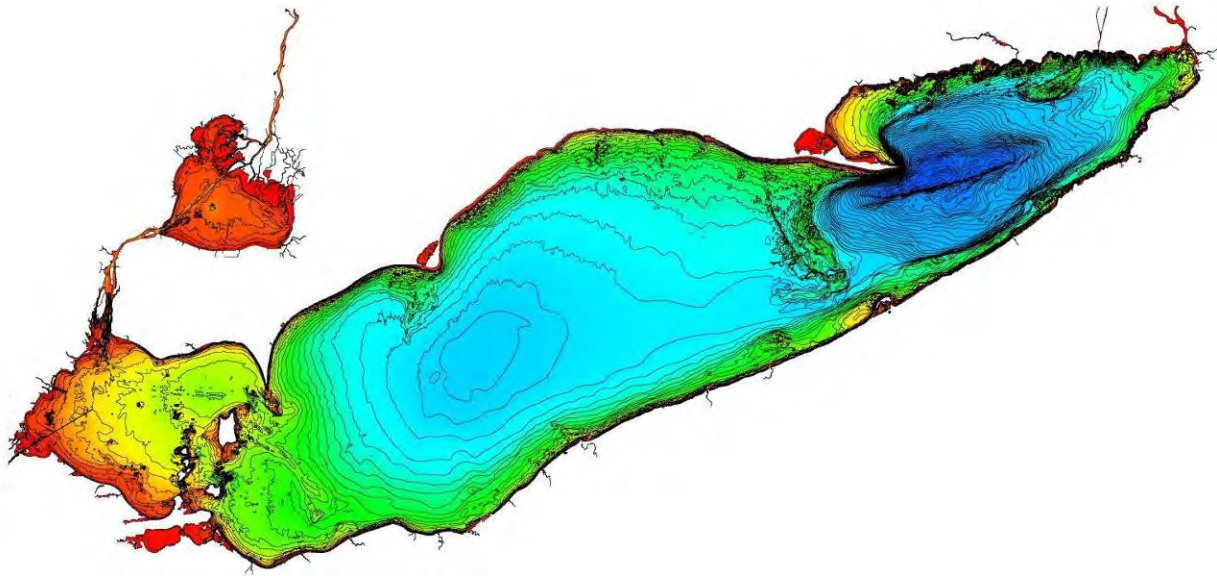

Figure 7 Bathymetric Map of Lake Erie (NOAA)

Lake Erie consists of three distinct regions: the western, central, and eastern basins. Each region has significantly different bathymetric characteristics. The western basin is the shallowest with an average depth of 24 feet (7 meters) and features rocky outcrops, shoals, and islands (Waterkeeper, 2014). The central basin has a large flat bottom with an average depth of 60 feet (18 meters) and a maximum depth of 80 feet (24 meters) in a broad depression in the middle of the lake (Waterkeeper, 2014)(NOAA, 2014d). In contrast, the eastern basin contains a sharp, deep gouge with several escarpments, an average depth of 80 feet (24 meters), and the deepest depths of the lake off the tip of a long sandy peninsula (Waterkeeper, 2014). The *Sultan* lies in the central basin near the southern shore as shown in Figure 8 (NOAA, 2014c).

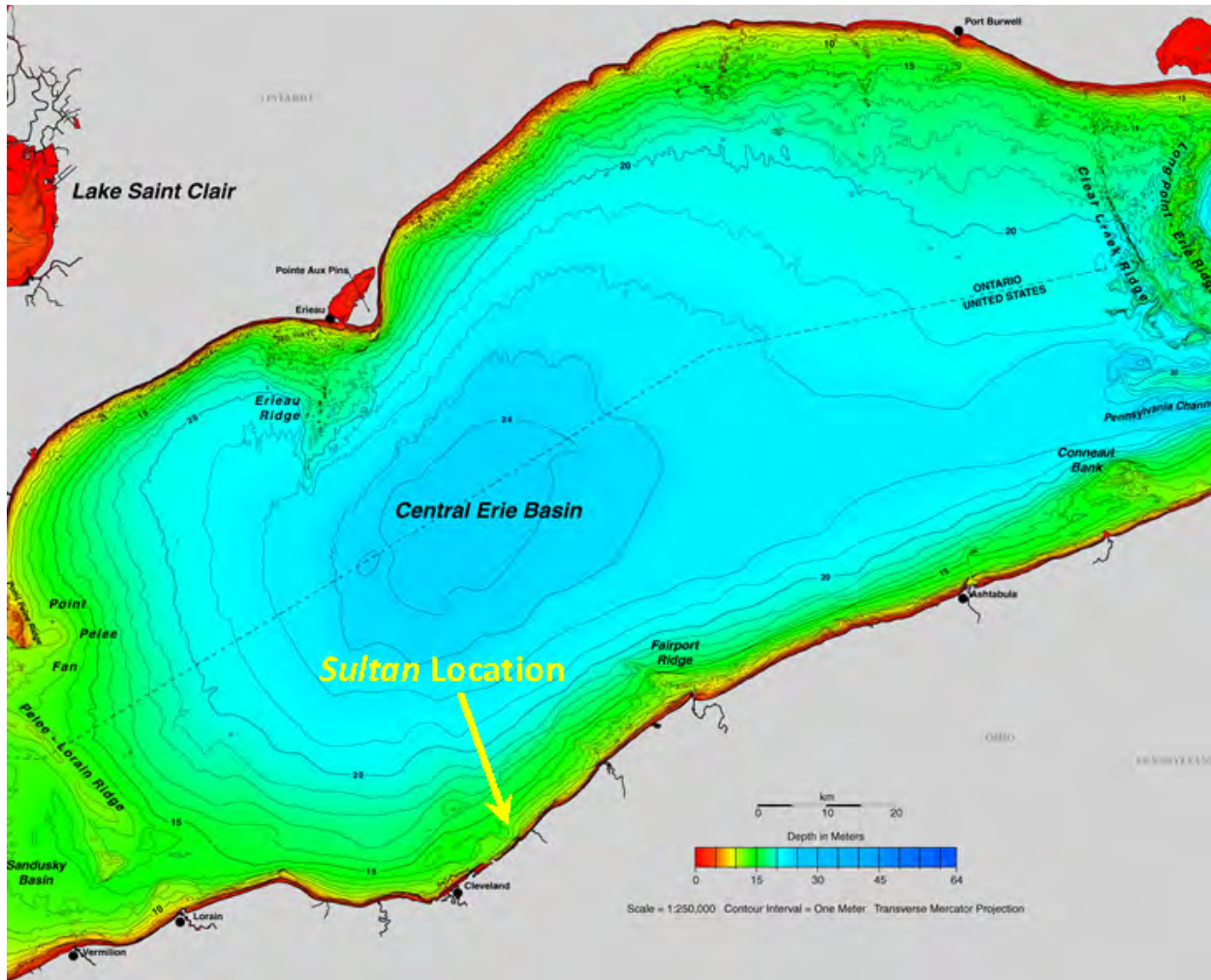

Figure 8 Bathymetric Map of the Central Basin of Lake Erie (NOAA)

Due to the wreck's location in the central basin, the bottom around the *Sultan* is relatively flat, although its location near shore does allow for a sharper change in depth as one moves towards or away from the shoreline. The wreck itself lies at a depth of approximately 43 feet (13.1 meters), and a detailed bathymetric view of the area is shown in Figure 9 (NOAA, 2014c). The wreck lies very nearly on the 13-meter depth contour, which forms a hook-shaped peninsula at that location. This peninsula could be either the edge of an eroded underwater valley from a prehistoric creek when lake levels were lower or the alluvial deposits from Euclid Creek, which lies just two miles to the east.

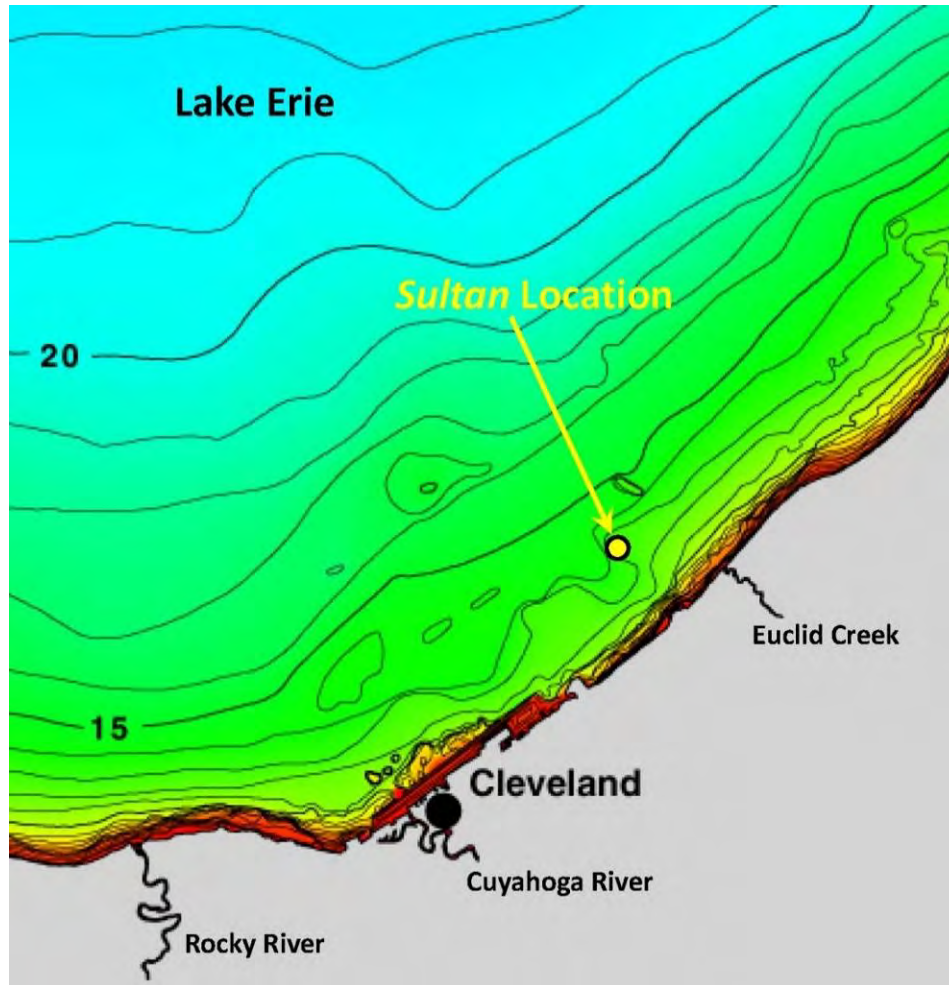

Figure 9 Bathymetric Map of Area around *Sultan* (NOAA)

A detailed sidescan of the area around the *Sultan* is shown in Figure 10, and it reveals that the bottom in the immediate vicinity of the wreck is mostly flat with some small rocks or debris randomly distributed across the bottom. There are some patches of sonar-absorbent sediment, probably silt or mud that fills bottom depressions, approximately 250 feet (75 meters) to the south. The most prominent bathymetric feature in the area, however, is the large trench of disturbed bottom that runs northwest to southeast. It is 500 feet (150 meters) to the north and 600 to 700 feet (180 to 200 meters) to the east of the wreck. This is the charted buried water pipe for the Euclid water intake, which is located northwest of the wreck.

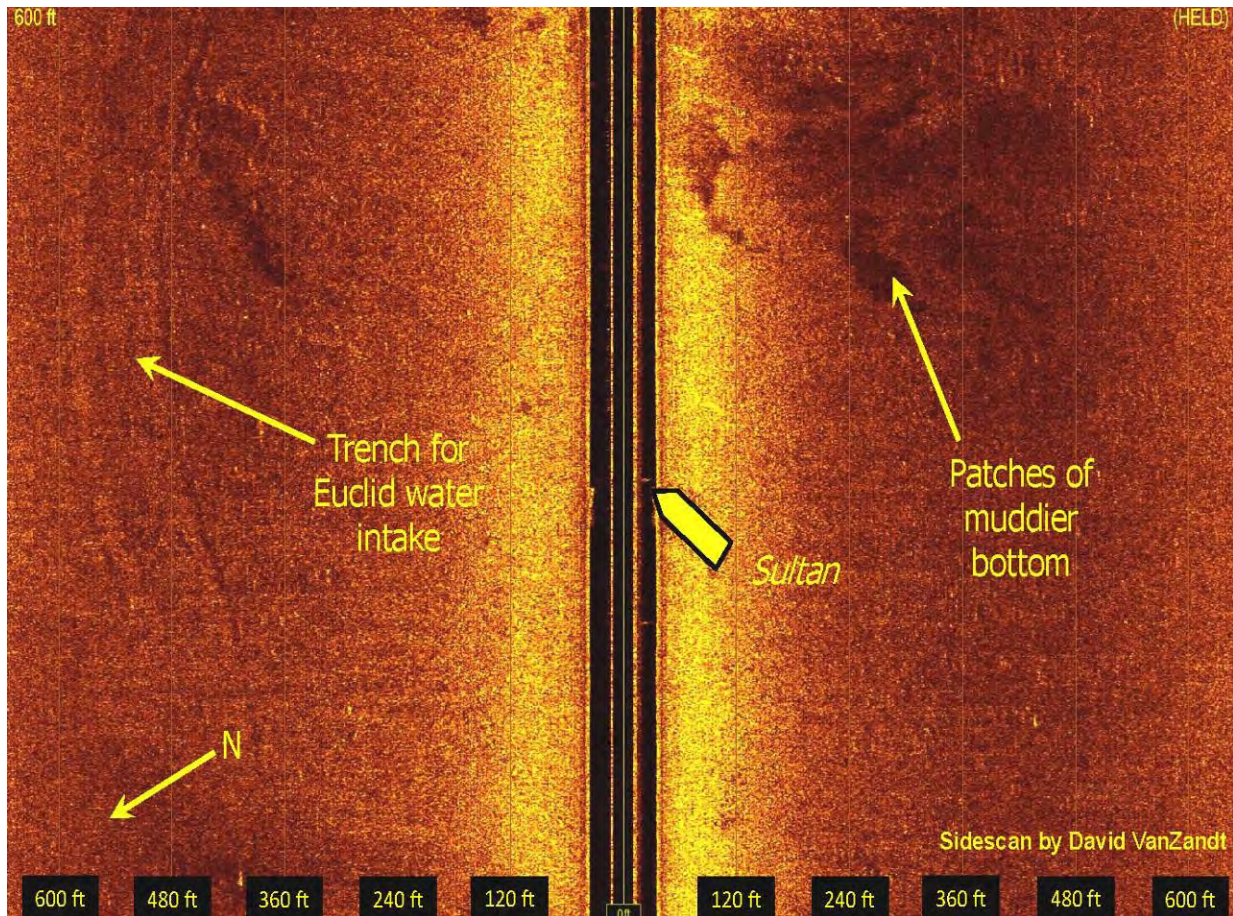

Figure 10 Sidescan Sonar of Area around *Sultan* (David VanZandt/CLUE)

Geology

The Great Lakes were formed predominantly by glacial processes. After repeated carving by glaciers during the Pleistocene epoch, only Paleozoic sedimentary rocks remain under northern Ohio (Dames, 1974). The Paleozoic bedrock exposed under Cleveland is from the Upper Devonian period and roughly dates to between 360 and 380 million years ago (Dames, 1974). This rock is mostly shale and is exposed in cliffs along Lake Erie’s shoreline both to the east and west of the city (Carter, 1982). The basin containing Lake Erie itself was carved into this bedrock by repeated Pleistocene glaciations (Dames, 1974). During the last period of Wisconsinan glaciation, the ice moved from the northeast to the southwest to create the lake basin known today (NOAA, 2014d). During the Wisconsinan ice sheet’s retreat starting 14,000 years ago and ending 12,600 years ago, glacial till deposits were left behind (Carter, 1982). These deposits are generally unstratified hard clay and gravel called basal till (Carter, 1982).

Additional deposits are stratified and clay-rich, and these are called flow till (Carter, 1982). They were created in a deep prehistoric lake that existed until the ice sheet fully retreated (Carter, 1982).

After the start of the Holocene 12,600 years ago, fine-grained lake sediments were deposited above the Pleistocene till layer (Carter, 1982). These post-glacial sedimentary deposits consist of either soft silt or sand in various mixtures. A cross section of Lake Erie water, silt, till, and bedrock is shown in Figure 11 running along the axis of the lake offshore of Cleveland (Dames, 1974). It should be noted both the bedrock and till layers are uneven in their boundaries.

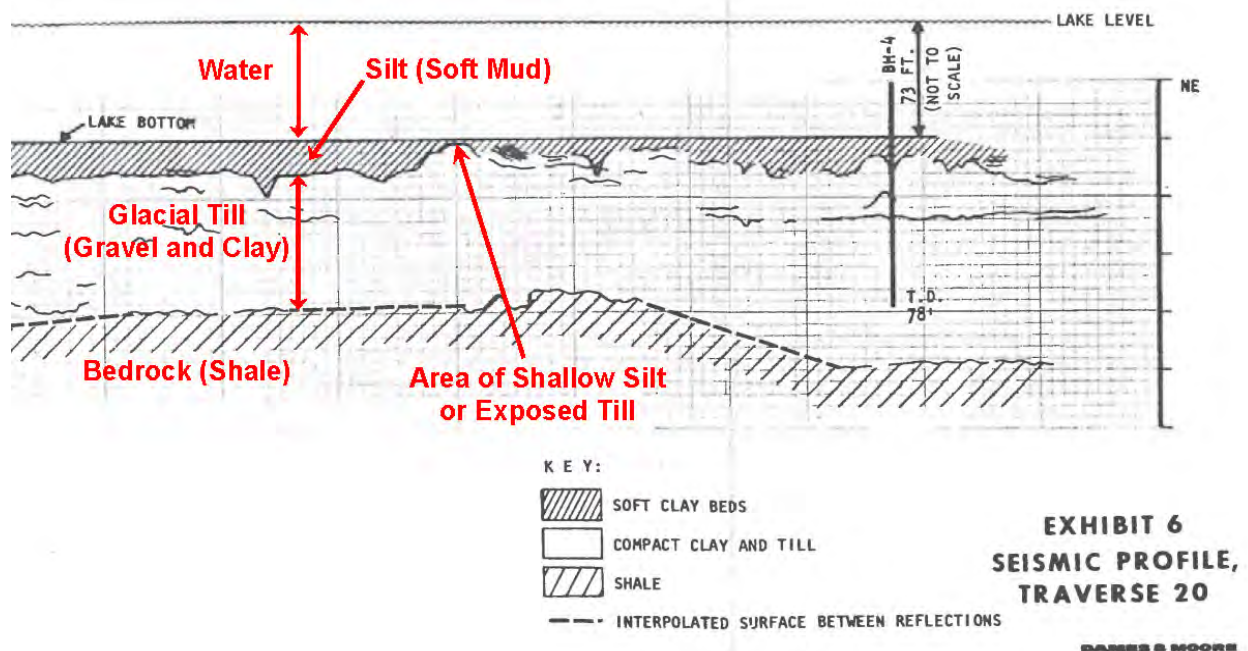

Figure 11 Example Southwest-to-Northeast Geologic Cross Section, Lake Erie off Cleveland, Ohio (Dames and Moore)

A geologic study performed by the U.S. Army Corp of Engineers in 1982 provides information of the geology in the immediate area of the *Sultan*. Figure 12 shows four summary maps off Cleveland (Carter, 1982). Both the surface sediment and till contour maps show the wreck is lying on exposed glacial till at a depth of 50 feet (15 meters) below the lake surface, which is roughly the water depth. The till isopach map shows the thickness of the till layer under

the wreck is roughly 65 feet (20 meters), and the bedrock begins at a depth of 115 feet (35 meters) below the lake surface.

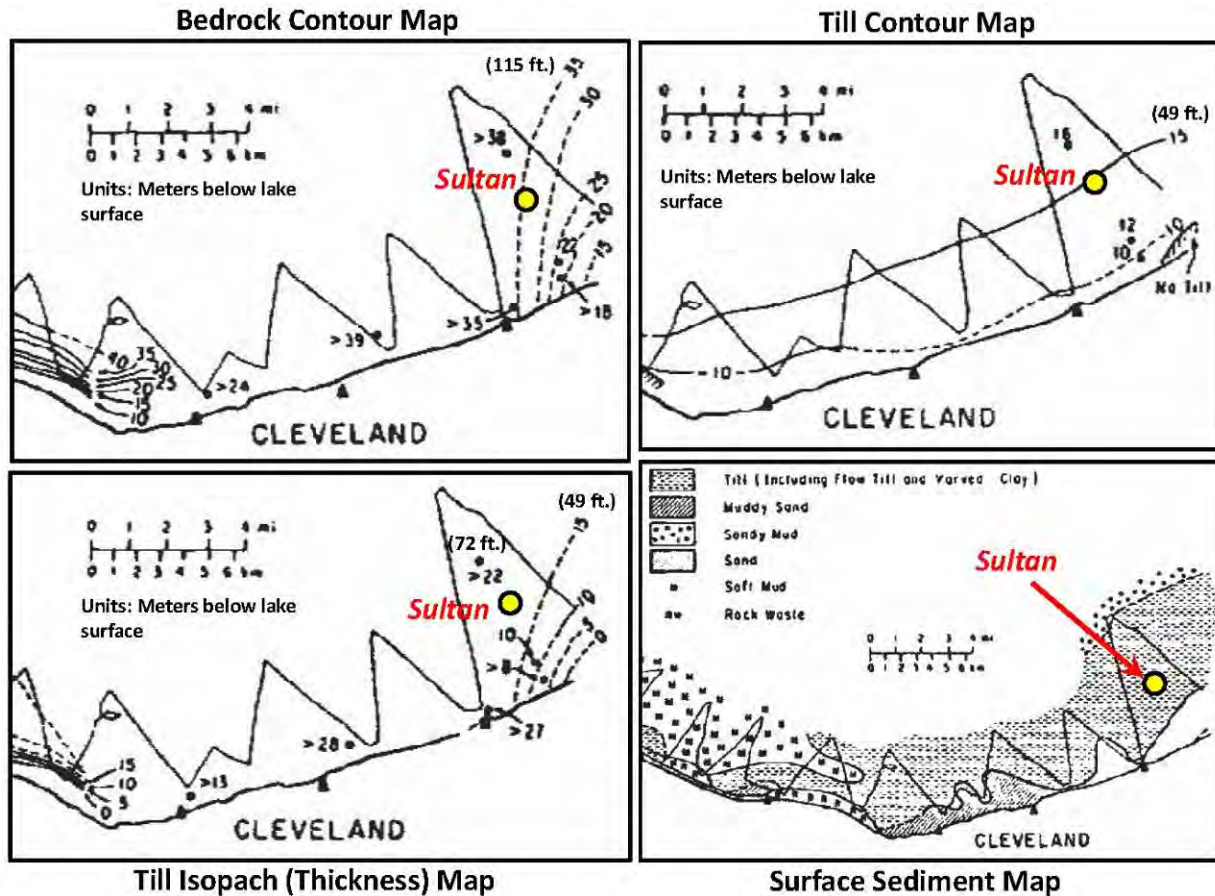

Figure 12 Near-Shore Sediment, Till, and Bedrock Summaries, Lake Erie off Cleveland, Ohio (U.S. Army Corp of Engineers)

Figure 13 shows a vibracore sample obtained by the 1982 geologic survey only one mile from the wreck site (Carter, 1982). It was able to penetrate only 10 feet (3 meter), but it confirms the bottom composition in the area of the *Sultan* is silty clay with minor gravel. No post-glacial sediment is evident, and it is exposed glacial flow till.

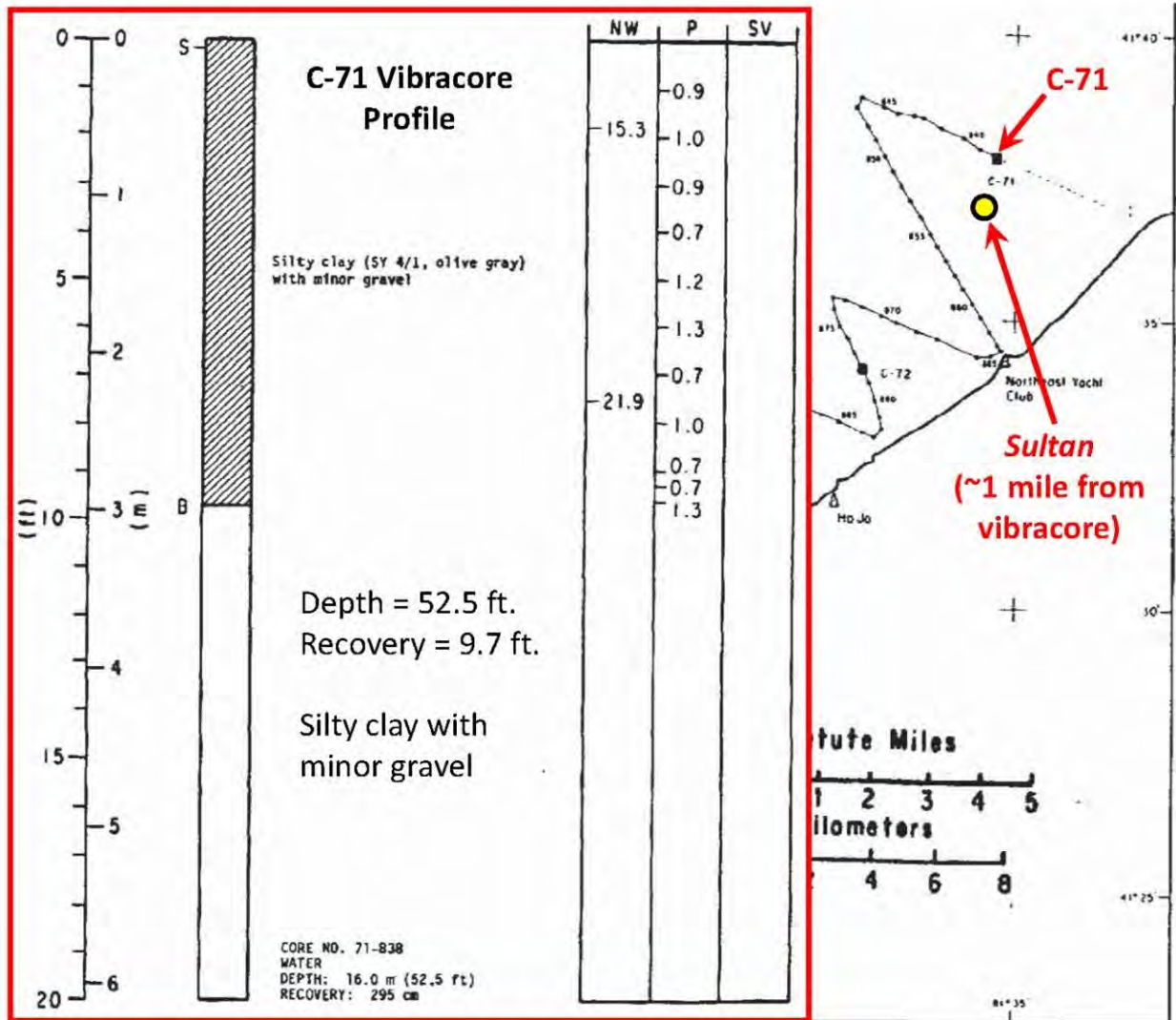

Figure 13 Vibracore Profile near *Sultan*, Lake Erie (U.S. Army Corp of Engineers)

Flora and Fauna

Lake Erie is the most biologically productive of all of the Great Lakes and contains a large, active freshwater fishery (Waterkeeper, 2014). The lake’s productivity is due mostly to the large abundance of phytoplankton, small plants in the water column which form the basis of the food chain (NOAA, 2014b). The warm lake water temperatures due to the relatively shallow depths and an abundance of nutrients from rivers help the phytoplankton thrive. Green alga, a single celled plant, is the most important and the basis of the summer food web (NOAA, 2014b). Diatoms, flagellates, and blue-green algae (cyanobacteria) are also present, especially in the early spring or late summer months (NOAA, 2014b). An overabundance of both phosphoric

nutrients and summer sunlight can lead to algae blooms that are a significant environmental problem.

The phytoplankton serves as food for a variety of creatures in the lake, including zooplankton and macroinvertebrates (NOAA, 2014b). Zooplankton, small animals in the water column, feed on both the phytoplankton and each other (NOAA, 2014b). Macroinvertebrates (larval insects, worms, amphipods, or mollusks) feed on the phytoplankton or detritus on the bottom (NOAA, 2014b). Foraging fish (perch, shad, drum, catfish, carp, and gobies) eat both the zooplankton and macroinvertebrates (NOAA, 2014b). These fish are then eaten by the piscivores, or the top predatory fish, such as walleye, bass, and trout (NOAA, 2014b).

Figure 14 illustrates the food web of Lake Erie (NOAA, 2014b). At the bottom of the web are the phytoplankton colored in green. The next level is comprised of the zooplankton and macroinvertebrates colored in light blue and orange, respectively. The third level is made up of the foraging fish shown in dark blue, and the top level includes the piscivores colored in purple.

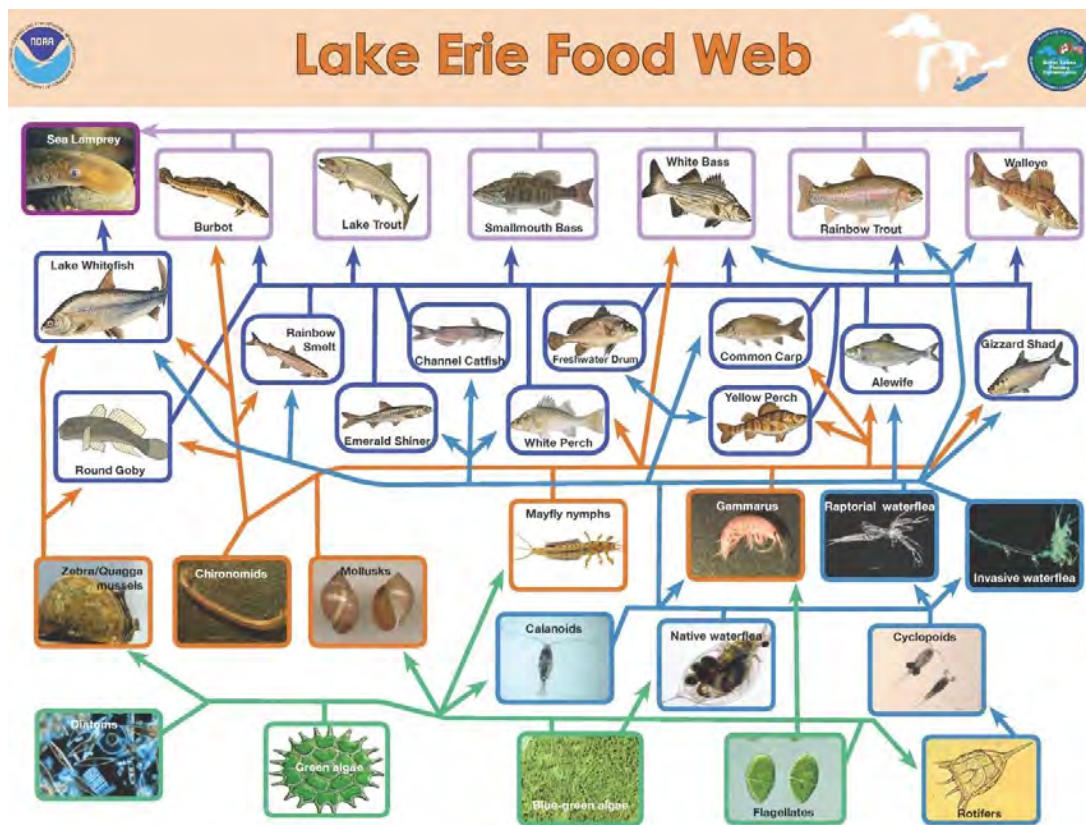

Figure 14 Lake Erie Food Web (NOAA Great Lakes Environmental Research Laboratory)

When diving the wreck of the *Sultan*, limited fauna is normally observed. The most common animals encountered are the zebra or quagga mussels (*Dreissena polymorpha* and *Dreissena bugensis*) affixed to the wreck itself (NOAA, 2014b). These are invasive mollusks introduced into Lake Erie in 1988-1989 (USGS, 2014a). They are filter feeders and remove large amounts of phytoplankton from the water eliminating an important food source for other Lake Erie animals (USGS, 2014a). They can also obscure the artifacts from easy identification and viewing and be destructive to the wreck itself by pulling off small pieces of wood when they die. Zebra mussels were introduced through ballast water discharges of ships coming from the coastal Black Sea region, where the mussels are native (USGS, 2014a). Later, quagga mussels, a similar species from the same area, appeared and may have now largely supplemented or replaced the zebra mussel, although it is hard to differentiate between the two species (USGS, 2014a).

The second most commonly observed animal on the wreck is the round goby (*Neogobius melanostomus*) (NOAA, 2014b). It is also an invasive species, and this bottom-feeding fish was introduced through ballast water discharges from the same region of the Black Sea as the mussels (USGS, 2014b). It eats the mussels as well crustaceans, insects, and small fish (NOAA, 2014b). Gobies can frequently be observed resting on the bottom or on various surfaces of the wreck.

Small schools of yellow perch (*Perca flavescens*) have occasionally been observed on the wreck (NOAA, 2014b). They eat zooplankton and macroinvertebrates, including the mussels (NOAA, 2014b). Individual freshwater drum (*Aplodinotus grunniens*), which are also foraging fish, occasionally visit the wreck (NOAA, 2014b). In the mid-water above the wreck are almost certainly walleye (*Stizostedion vitreum*), but these fish are rarely observed due to the limited time divers spend in the mid-water and due to the fishes' dislike for the presence of divers (NOAA, 2014b). The walleye eat both the gobies and perch that aggregate around the wreck for food and shelter (NOAA, 2014b).

No flora has been observed on the wreck. However, phytoplankton, especially green algae, is usually present in the water column. The amount of algae present can dramatically affect the visibility on the shipwreck and the brightness of the ambient light on the bottom.

During algal “blooms”, most common in late summer, algae may be observed directly on the surface waters as large green slicks or individual globules.

6) Survey Design

Objective

The objective of the activities of the Maritime Archaeological Survey Team Inc. was to document in planimetric (2-dimensional) form the dimensions, features, and artifacts of the wreck site and, if possible, the associated debris field. The historical value of the site itself is many-faceted and includes the obvious example of period shipbuilding as well as the concomitant examples of stoneware, tools, utensils, ironwork, and grindstones.

A planimetric format for the survey was chosen for several reasons. First, due to the significant settling of the wreck in the lake bottom sediments, the aspect of the vertical portions of the vessel provided little to document. Next, a planimetric survey required significantly less participant training than a survey conducted in three-dimensions. Because the vast majority of the personnel involved in the survey were volunteers with an avocational interest in maritime archaeology, the training and talents of the available participants was a major consideration in the selection of the survey technique used. Finally, a planimetric survey could be completed in fewer days and dives, thus reducing costs. The Maritime Archaeological Survey Team Inc., a not-for-profit organization, had limited funding to cover survey expenses.

The survey was conducted with the goal of producing 1) a dive slate for recreational SCUBA divers interested in the site and its cultural heritage, and 2) a report accessible to amateur as well as professional archaeologists interested in the deposition of the wreck on the bottom of Lake Erie and the history surrounding how it came to rest there.

Survey Team Project Management Structure

The survey management team was comprised of the following individuals and their assigned roles:

Chris Kraska – Project Manager, MAST

David M. VanZandt MMA, RPA – Chief Archaeologist, CLUE/MAST

Carrie Sowden MA – Archaeologist, GLHS Representative, and MAST coordinator

Ken Marshall – Dive Safety Officer, CLUE/MAST

Linda Pansing- Dive Coordination, Topside Photographer

Scott Pansing- Asst. Project Manager

Patrick Enlow- Dive Safety Officer

Vince Frodl- Dive Safety Officer

Survey Methodology

Plans were made in the Spring of 2012 for the organization of the *Sultan* Survey. MAST and CLUE agreed that the planimetric survey would use a system of control points fixed in place on the frames of the wreck. A control point system was chosen in favor of a static baseline due to length of the wreck, 125 feet. The static baseline would have required the installation of a steel cabling system to ensure that the baseline provided an accurate fixed position from which accurate survey measurements could be taken. Past problems associated with long unsupported baselines have included sagging, bowing from currents, diver interactions, and the lack of a clear path across the length of the vessel from bow to stern all of which introduce error into the detailed measurements due to the variance in elevation of the baseline.

After some discussion, yellow plastic tags of the type commonly used to identify cattle were selected for use as control point markers due to their bright color and the fact that they are available pre-numbered. In order to affix these tags to the wreck, heavy duty zip ties of approximately 20” in length were chosen for their ease of installation, sturdiness, and minimal impact on the structure of the wreck (Figure 15).

The Primary control point network was developed from the mud map (Figure 16) and plan view (Figure 17) created by CLUE during their initial survey of the wreck. The primary network consists of 12 points on the wreck itself and 2 outlying control points, which were ½ inch steel rebar rods driven into the lake bottom to serve as permanent fixed points should future work be undertaken.



Figure 15 Control point marker (Photo by David VanZandt, CLUE)

Sultan Survey Report

Kevin Magee
Tom Kovalczek
David Von Zant
8/12/11

mast hole = 2" ϕ
mast = 1.5" ϕ

groundstone
DIA = 5.5'

slot = 1" x 5"

slot = 1.5" x 5"

2x wood barrel pump
no notch, mast missing aft?

DIA = 3.5" ϕ

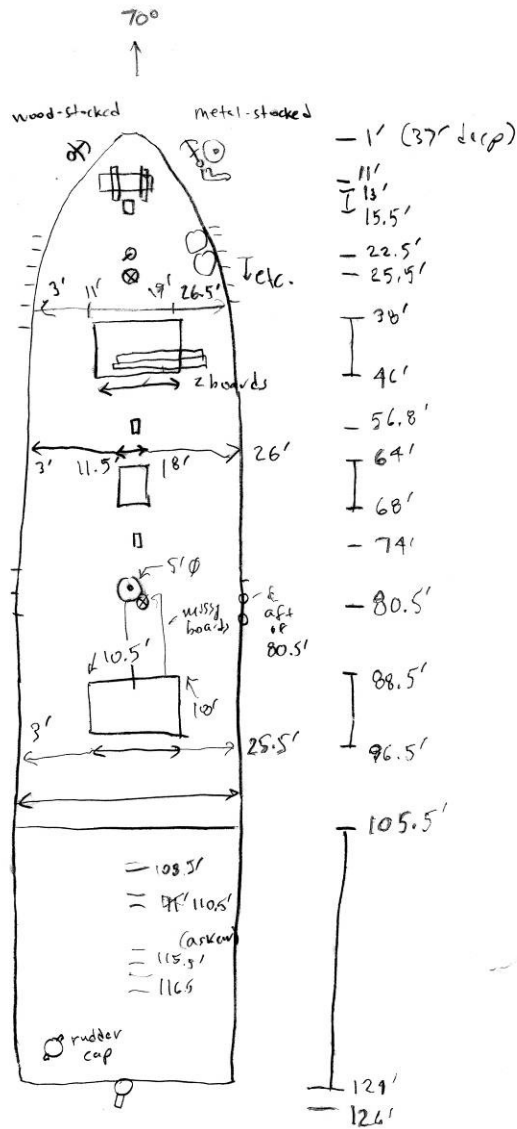

Figure 16 Sultan mud map (Sketch by Kevin Magee, CLUE)

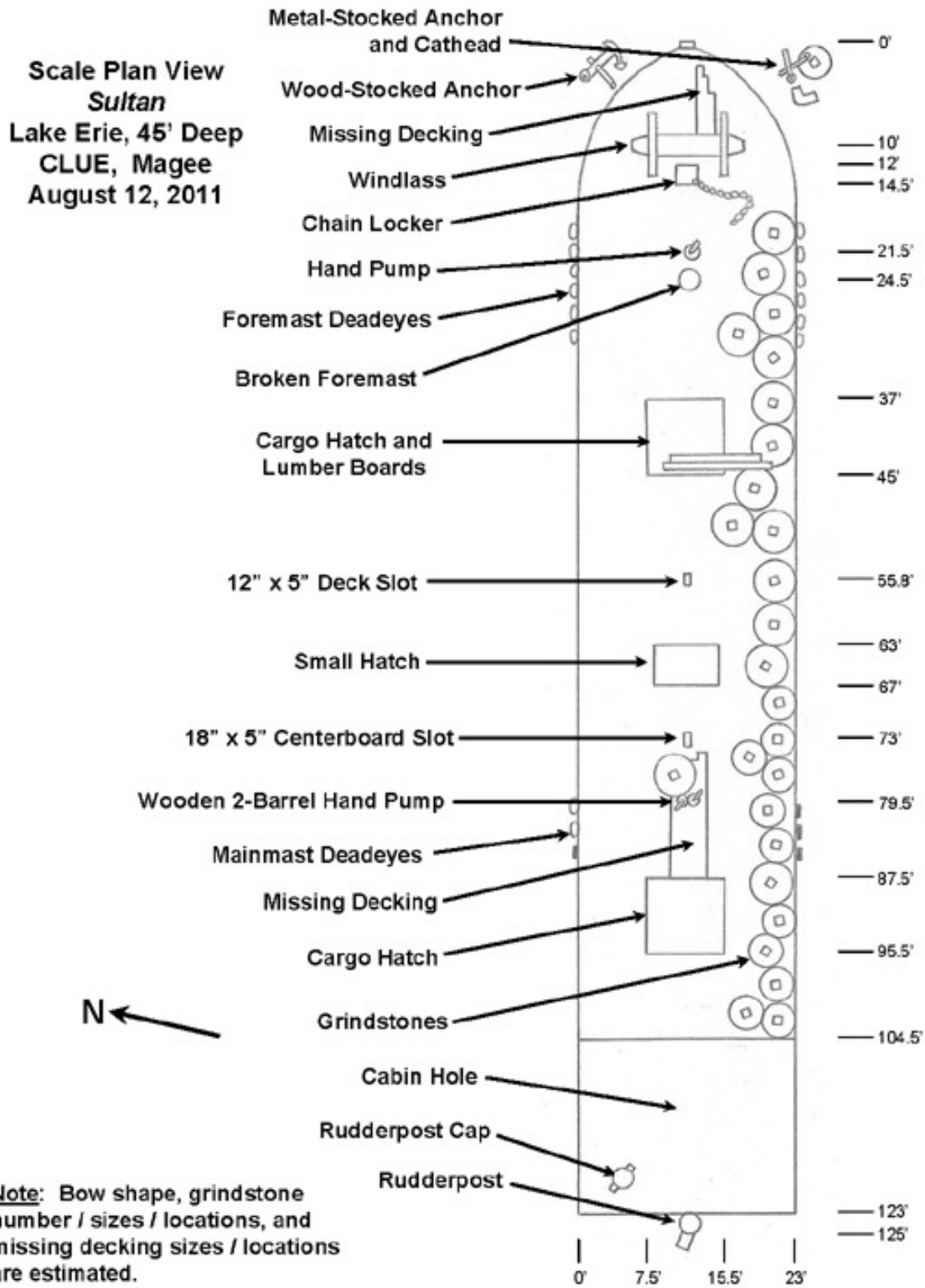

Figure 17 *Sultan* plan view (Kevin Magee, CLUE)

Once the locations of the primary control points were determined and markers installed, the control points were surveyed in. The survey results were then entered into 3H Consulting Ltd's Site Recorder 4 Survey software and checked for accuracy (Figure 18).

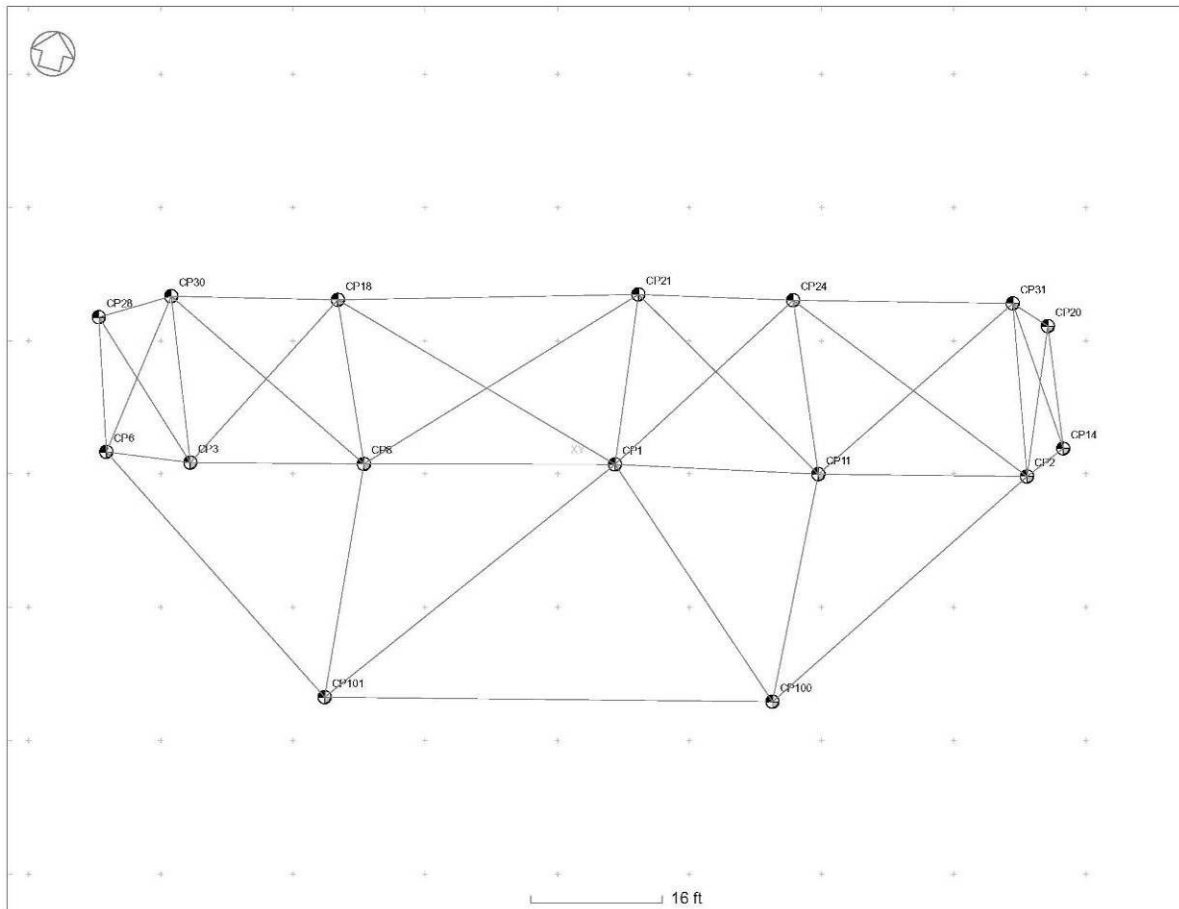

Figure 18 Primary control point network (David VanZandt, CLUE)

After the primary control point network was installed a secondary control point network of 13 points was established to relieve congestion on the primary control points when utilizing multiple dive teams. These points were installed and surveyed into the primary control point network. The measurements were then entered into 3H Consulting Ltd's Site Recorder 4 Survey software and checked for accuracy (Figure 19).

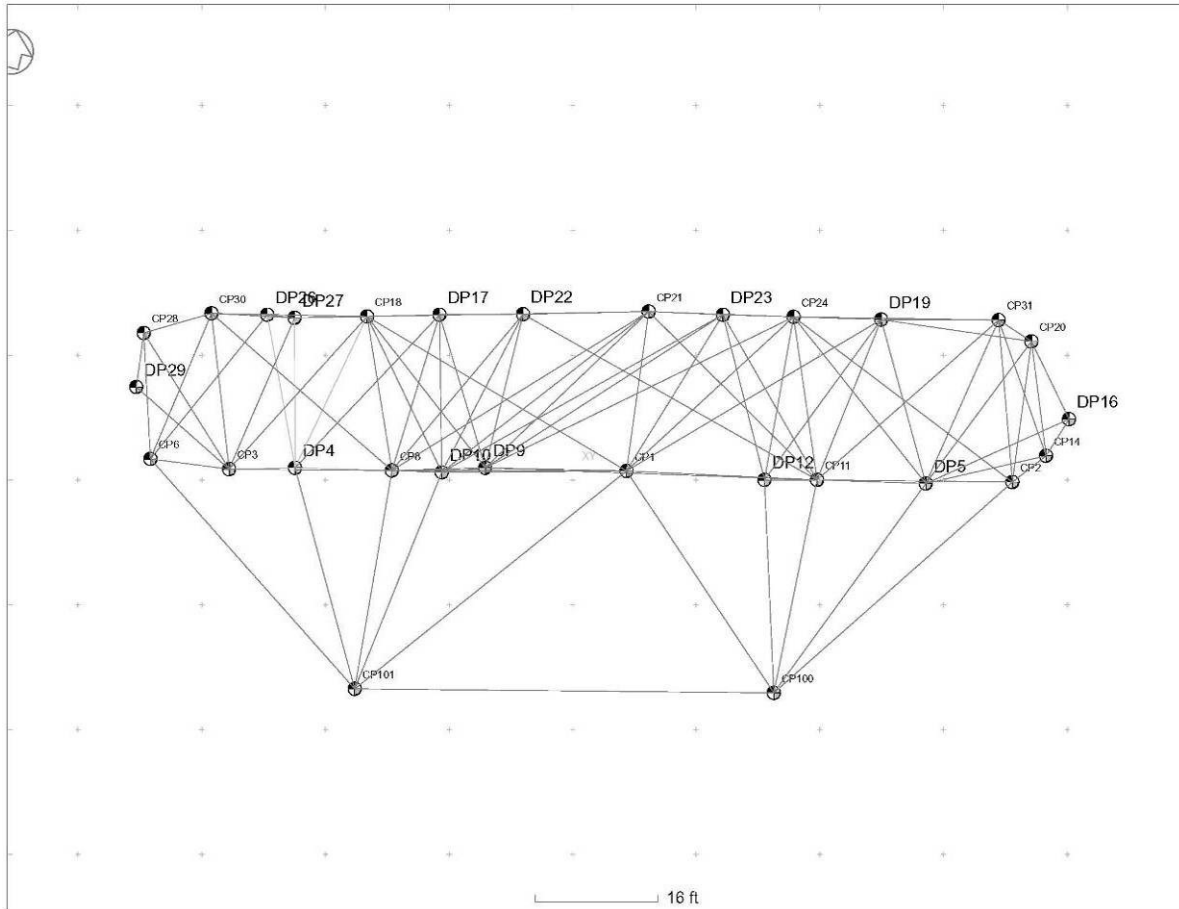

Figure 19 Primary and secondary control point networks (David VanZandt, CLUE)

Survey Training

The survey of the wreck site was conducted by members of MAST and CLUE. All participants in the site survey had attended and participated in at least one GLHS/MAST workshop which focused on subjects such as historical shipbuilding, ship parts, Great Lakes maritime history, shipwreck law, historical research, and survey protocol and techniques. GLHS with assistance from MAST conducts a nautical archaeology workshop each spring that offers training at various levels: Beginner, Advanced, and Survey. Many of the workshop instructors are also participants in surveys like that of the Sultan. In addition to GLHS/MAST training, several of the CLUE survey divers had additional training that included Nautical Archaeology Society (NAS) certification at levels 1 and 3.

Pre-dive Planning Aids

In order to assist project management and the dive teams in their assigned survey tasks several pre-dive planning aids were developed from the initial pre-disturbance survey performed by CLUE. The first planning aid was an annotated sidescan sonar image of the wreck to help with pre-dive planning and provide an overall site description (Figure 20).

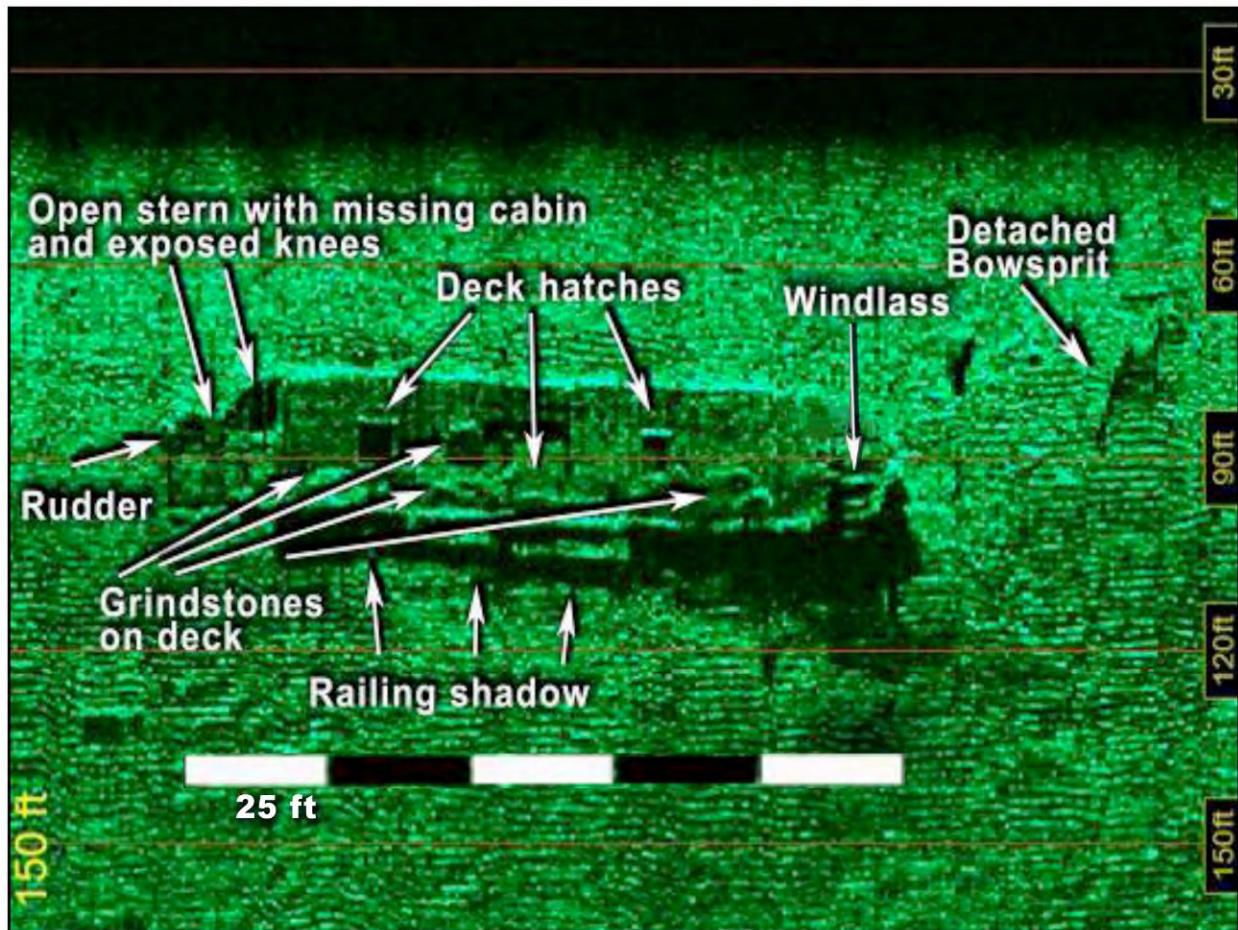

Figure 20 Sidescan sonar image with detail (CLUE).

The next aid developed was a teaching aid for divers detailing how to perform the measurements needed using the control points and where the control points were physically located on the wreck for orientation purposes (Figure 21).

Survey Measuring Instructions

1. Place the "0" end of the tape reel directly on the hole of the tag of the control point. Avoid moving the control point tags when taking measurements.
2. The tag and tape should not have any slack in them but shouldn't be pulled to the point of stretching and should be level. The use of a plumb bob may be necessary.
3. Note the control point numbers clearly on the baseline location of the trilateration sheet.
4. Measure each object from at least two control points.
5. Control points for measuring should be chosen to give the closest approximation to a triangle with two equal sides.
6. When measuring objects such as grind stones, measurements should be taken at the center (the hole) if possible. The hole in the grind stone should also be measured as should the outside diameter.
7. If the path of the tape reel is obstructed from a control point choose a different control point.
8. When taking measurements of features on which a control point is placed note the position of the control point on the object in your sketch.
9. When measuring features such as hatches, take measurements to two diagonal corners and measure all sides of the feature.
10. If you discover interesting objects make a quick sketch, as detailed as possible, and note its location on the wreck site in relation to a control point. As of now, do not measure objects that are not directly on the wreck.



Sultan sketch by Kevin Magee

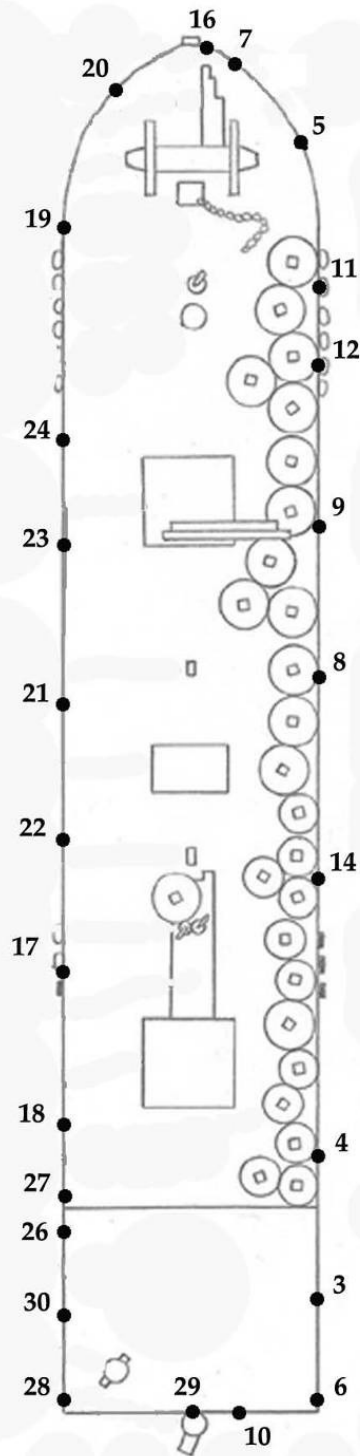

Figure 21 Survey measurement instruction aid (MAST)

Another pre-dive planning aid used for survey management was a task sheet (Figure 22). This sheet was developed to assist in prioritizing the day's activities and manage dive team location assignments to prevent congestion and minimize silting conditions.

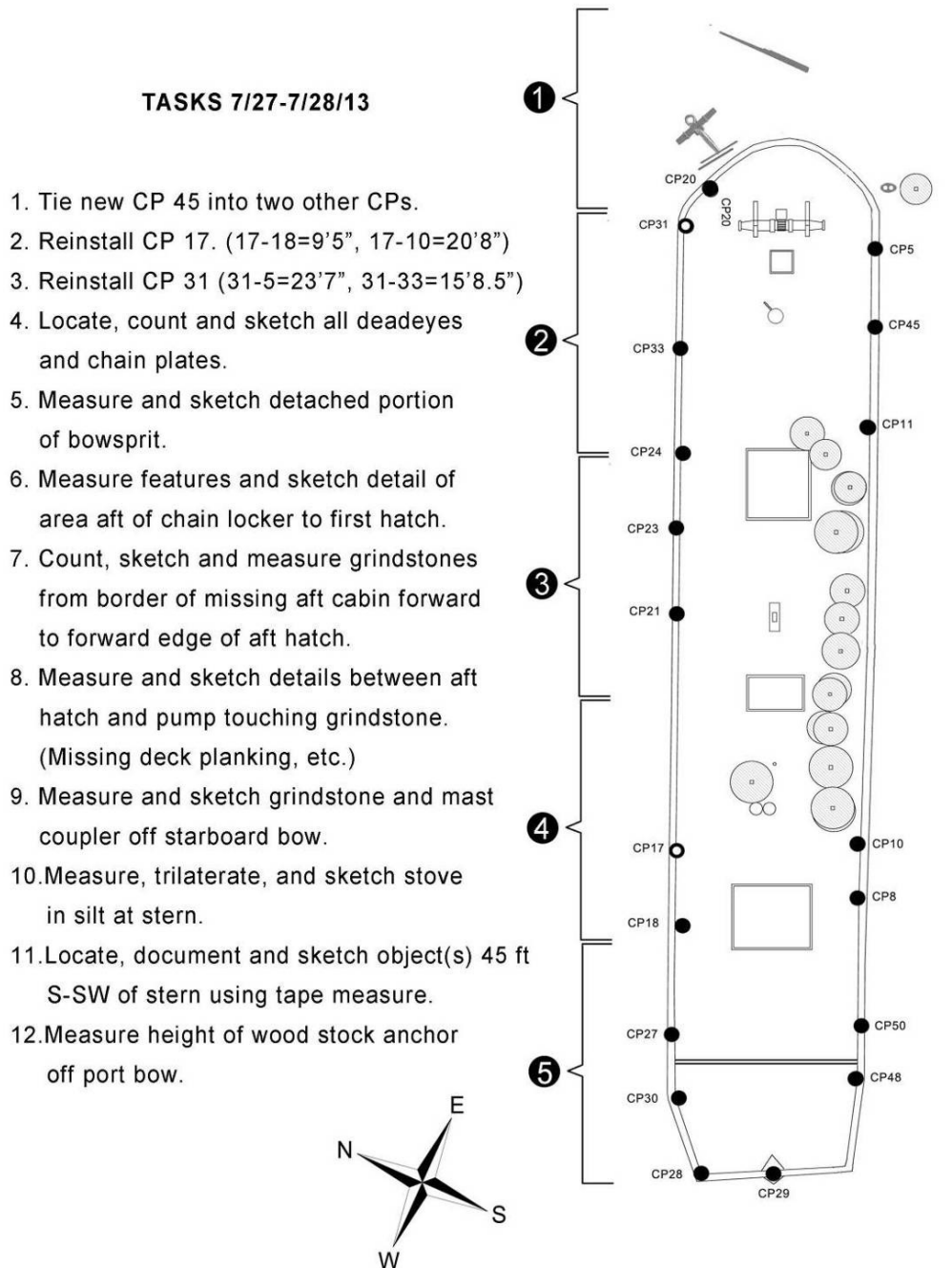

Figure 22 Pre-dive Task List Example (MAST)

Sultan Survey Report

Survey data recording sheets were used by the dive teams to record their measurements. The measurement recording sheets, previously created for baseline tri-lateration, were adapted for control point tri-lateration measurements (Figure 23).

Date:	Names:	
Location:	Site:	
Section:	Standard / Metric	Day's Dive #
BL	Notes and Drawings	BL
DIS		DIS
PNT		PNT
BL		BL
DIS		DIS
PNT		PNT
BL		BL
DIS		DIS
PNT		PNT
BL		BL
DIS		DIS
PNT		PNT
BL		BL
DIS		DIS
PNT		PNT
BL		BL
DIS		DIS
PNT		PNT
BL		BL
DIS		DIS
PNT		PNT
BL		BL
DIS		DIS
PNT		PNT

Figure 23 Measurement recording sheet (MAST)

Dive Safety

As with any field activity, and especially with one that involves SCUBA diving, safety was of primary importance. Managing safety starts by building it into the process through criteria, communicating it clearly through education and repetition, and incorporating it into the objective. All prospective members of MAST are required to participate in the GLHS/MAST Nautical Archaeology Workshop before they can become members and participate in surveys. The workshop includes a lecture on safety, which is re-iterated in a safety briefing at the quarry practice sessions. All safety lectures/briefings start with our philosophy: “Safety is top priority. Fun and meeting objectives are second to safety.”

The primary criterion requires that all divers hold a certification from a nationally recognized training agency. The second criterion maintains that each diver is responsible for his/her own decision to dive/not dive. The “no recriminations” philosophy that developed out of the safety work by the cave/technical diving communities is followed. A quarry diving experience is incorporated into the workshop as a survey learning step and shake-down dive making the transition from dry classroom work to full survey diving from a boat safer and less problematic. Additional criteria include: a) No solo diving and b) No “messaging around” with other divers. This is a group/community effort focused on a common goal and individual desires (except personal safety) are to be left behind.

An archaeologist or project manager (A/PM) exercises administrative control over and directs daily dive activities assisted by a dive safety officer (DSO) focused solely on the diving operations. If a dive safety situation arises, the DSO is authorized to override the A/PM if necessary. The DSO is generally a dive master, assistant instructor, instructor, or person with dive management skills/training. On boat dives, the captain of the vessel is in ultimate control, but generally allows the A/PM and DSO the freedom to manage the diving/archaeology activities as they see fit. Prior to any boat trip, the captain provides a safety briefing specific to his vessel, including emergency procedures, signals for diver recall in cases of emergency or approaching inclement weather, and other aspects of boat safety. The A/PM provides a daily briefing of project objectives and the DSO provides a daily safety briefing on standards for planning and executing dives.

Dive teams are assigned by the A/PM with input from the DSO. Team objectives are assigned by the A/PM with a reminder from the DSO concerning the conditions for terminating a dive. These conditions are 1) no longer comfortable, 2) reach maximum allocated time or low on air, or 3) completion of the assigned tasks. Divers must check-in/check-out as a team at the water's edge for dive safety. Subsequently, the team reports to the A/PM regarding their underwater work and activities. The next team cannot proceed until the prior team has checked-in to ensure that an appropriate hand-off with reporting on conditions and tasks has been made.

The primary vessel used for primary survey dives in the 2012-2013 seasons was the *Holiday*, a charter boat operated by Trident Marine. MAST maintains its own DAN (Divers Alert Network) oxygen kit, but it was not needed as the *Holiday* carries a DAN kit in addition to a large stationary oxygen cylinder. MAST provides periodic DAN Oxygen Provider classes for its members, so there were typically multiple personnel on board certified to dispense oxygen. On any given day the personnel aboard the boat included multiple dive masters, SCUBA instructors, non-divers qualified in CPR and Emergency First Response, and even professional medical personnel. An emergency plan was in place at all times with the A/PM serving as the emergency coordinator and the DSO serving as care provider until other more qualified personnel became available. During the multiple survey dives and two summers of survey work there were no dive-related injuries which required first aid or the administration of oxygen.

7) Archaeological Documentation

Field Work

The underwater segment of the *Sultan* survey was conducted during the 2012 and 2013 field seasons. A total of 189 survey dives were completed spanning 10 separate diving days. Since the wreck is only accessible by boat, the R/V *Sea Dragon*, operated by David VanZandt, was utilized for three of the diving days, and the dive boat *Holiday*, operated by Trident Marine, was utilized for seven of the diving days. Normally on the morning of a scheduled diving day MAST members who had volunteered for the day's diving activities would arrive prior to the scheduled start time, check-in, and then stow and secure their personal diving gear aboard the boat. After safety briefings from both the boat's captain and the DSO, survey techniques were reviewed by the Project Manager. Questions were addressed as they arose (Figure 24).



Figure 24 Pre-dive survey technique briefing (Photo by Linda Pansing, MAST)

Sultan Survey Report

The *Sultan* site is approximately a 45-minute boat ride from the Trident Marine dock in the Cuyahoga River, Cleveland, Ohio. After arriving at the site and securing the boat to the mooring buoy (Figure 25), divers collected their survey equipment and suited up for their first dive. Survey equipment was secured to the divers' gear using d-rings, carabiners, and other attachments (Figure 26).



Figure 25 *Holiday* moored to *Sultan* buoy (Photo by Chris Kraska, MAST)



Figure 26 Survey diver ready to enter water (Photo by Linda Pansing, MAST)

Survey equipment used on the site included:

- Vinyl tape measures/reels
- plastic clip boards
- Mylar measurement recording and note sheets
- Plumb bobs with floats

Prior to entering the water, divers were paired up by the A/PM and given their respective assignments on the wreck. The wreck was divided into sections and specific tasks to help limit interference and encounters between dive teams. After gearing-up on deck, divers moved to the stern and were assigned individual clip-on DAN number tags by topside personnel. Each diver's number and data, including "air in" and "time in", were recorded.

Dive teams entered the water in one of two groups, which were staggered. Staggering helped to minimize silting on the wreck due to diver activity as well as prevent dive teams from working too close and interfering with one another (Figure 27).



Figure 27 Working survey diver (Photo by David VanZandt, CLUE)

Datum points and features to be recorded were noted and assigned on each dive team's Mylar note sheets, which were taped to a waterproof slate. Using the trilateration method of measurement, the distance from these objects or features to two separate control points was measured and recorded. Round items, such as the many grindstones on the wreck, had measurements taken to the center of their holes and had their diameters, beveled edges, and size of center holes measured and recorded independently.

Divers followed protocol and returned to the boat with at least 500psi of air remaining after spending no more than 30 minutes conducting survey tasks on the wreck. Once back on board, each diver's numbered tag was collected, their name checked off, their remaining air pressure and time out of the water recorded, and their bottom time calculated (Figure 28).



Figure 28 Divers returning and checking in (Photo by Linda Pansing, MAST)

After removing/stowing their dive equipment and drying off, divers copied their measurement recording and note sheet data onto standard paper and completed individual dive logs noting such items as their worksite location, dive/work conditions, and any issues encountered (either physical or survey related) (Figure 29). The Mylar measurement note sheets, transcribed “dry” data sheets, and individual dive logs were all returned to the A/PM. After reviewing the data, the A/PM determined the amount of work that was completed relative to the day’s goal and the amount of work that remained. Tasks for the second dive were adjusted, re-assigned, and/or added, as necessary. Such considerations as equipment malfunctions, illness, equalization problems, and other issues forced the restructuring of dive teams, tasks, and other specifics.



Figure 29 Diver transposing survey data from wet to dry notes (Photo by Linda Pansing, MAST)

While the first group of divers was returning to the boat, the second group was gearing up and going through the same pre-dive preparations as the first group. The groups overlapped by no more than a few minutes to minimize downtime. Once back on board, the second group of divers repeated the post-dive procedures, ate lunch, and awaited their second dive of the day.

After the survey work for the day was complete, all gear was stowed, and the boat commenced the return trip to the dock. All the data sheets and dive logs were inventoried and stored for evaluation by the A/PM.

In addition to the survey work done by in-water dive teams the use of remote sensing equipment in the form of 360 degree sonar imaging was employed. Brian Abbott of Nautilus Marine Group International, LLC volunteered his expertise and 360 degree sonar equipment to produce detailed images of the wreck site.

The technology uses a rotating sonar emitter and receiver on a tripod to scan the site 360 degrees. The use of multiple images from varying positions of the tripod results in the production of accurate sonar composite images of great detail (See Figures 81 and 82).

Brian and his colleague David Thompson travelled from Michigan with the equipment and joined Project Manager Chris Kraska, who provided and captained the boat, to create the high resolution scanning sonar images.

The Dive Site

The *Sultan*, Ohio Archaeology Inventory (OAI) number 33 CU 534, is located at 41° 35.685' N, 81° 36.936 W and sits upright on a sand/mud bottom in 42 feet of water. The wreck measures approximately 125 feet x 23 feet and is mostly intact although partially buried with the hull settled into the sand/mud on to a firmer sub-bottom. Silt has filled the interior spaces of the vessel (Figure 30), but a slight west-to-east current helps keep the upper structure of the wreck free of major silt. Due to its depth the wreck is not subject to shallow water ice damage, wind-driven surface currents, or wave action. Zebra or quagga mussels cover the vertical surfaces of the wreck to a moderate degree, necessitating the use of gloves by divers to prevent cuts from the sharp mollusk shells (Figure 31).



Figure 30 Silt-filled hold (Photo by David VanZandt, CLUE)



Figure 31 Mussels (Photo by David VanZandt, CLUE)

The deck and associated deck equipment are covered with a fine layer of silt which is easily stirred up by survey activities. When this condition occurs it can drop the visibility in local areas of the wreck to zero. The visibility at the dive site varied from day to day and ranged from zero to sometimes 20 feet of visibility with the average being about 3 feet. The lack of visibility made photography and video recording tenuous activities at best. Normal archaeological methods include having a scale and north arrow in frame when taking photographs of a site and site artifacts. Due to the silting conditions present, these were not commonly employed.

Most survey dives were completed during the summer months. The water temperature at these times varies from about 60 to 70 °F with little to no thermocline due to the shallow depth of 45 feet.

The ship's bow, missing the bowsprit, is pointed east and stands five feet high off the sand/mud bottom (Figure 32). The hull sides are intact and the majority of the decking is present. Two anchors are present and visible lying on the bottom off either side of the bow. A wood-stocked bower anchor is partially buried on the port side still attached to its anchor chain (Figure

33). A metal stream or small bower anchor, with a 90 degree-shaped wooden cathead still attached to it, is mostly buried on the starboard side with a grind stone on top of it (Figure 34).



Figure 32 Bow with missing bowsprit (Photo by Chris Kraska, MAST)



Figure 33 Wood-stock bower anchor, port side (Photo by Chris Kraska, MAST)



**Figure 34 Metal stream or small bower anchor with attached cathead, starboard side
(Photo by David VanZandt, CLUE)**

The bow of the ship features a prominent cutwater with a notch for the missing bowsprit (Figure 35). The disarticulated bowsprit rests on the bottom 42 feet to the east of the bow (Figure 36). A windlass (Figure 37) is located on the forward deck just aft of the bowsprit notch (Figure 38). Aft of the windlass is a small square access opening in the deck to the chain locker, which is filled with anchor chain. Two separate anchor chains run from the chain locker. The port anchor chain runs from the chain locker through its spurling pipe and loops back into the chain locker. It then comes back out of the chain locker where it wraps around the port whelp of the windlass (Figure 39). From the whelp it continues its run along the deck to the port hawse pipe and presumably out to the partially buried port anchor. The starboard anchor chain runs out of its spurling pipe and is separated at this point (Figure 40). After the separation the remaining starboard anchor chain wraps around the starboard whelp of the windlass. From the starboard whelp it continues it runs along the deck (Figure 41) to the apparently ripped out hawse pipe continuing off the deck and down the side of the ship presumably out to the partially buried starboard anchor.



Figure 35 Bow and cutwater (Photo by Jack Papes, Akron, Ohio)



Figure 36 Bowsprit (Photo by David VanZandt, CLUE)

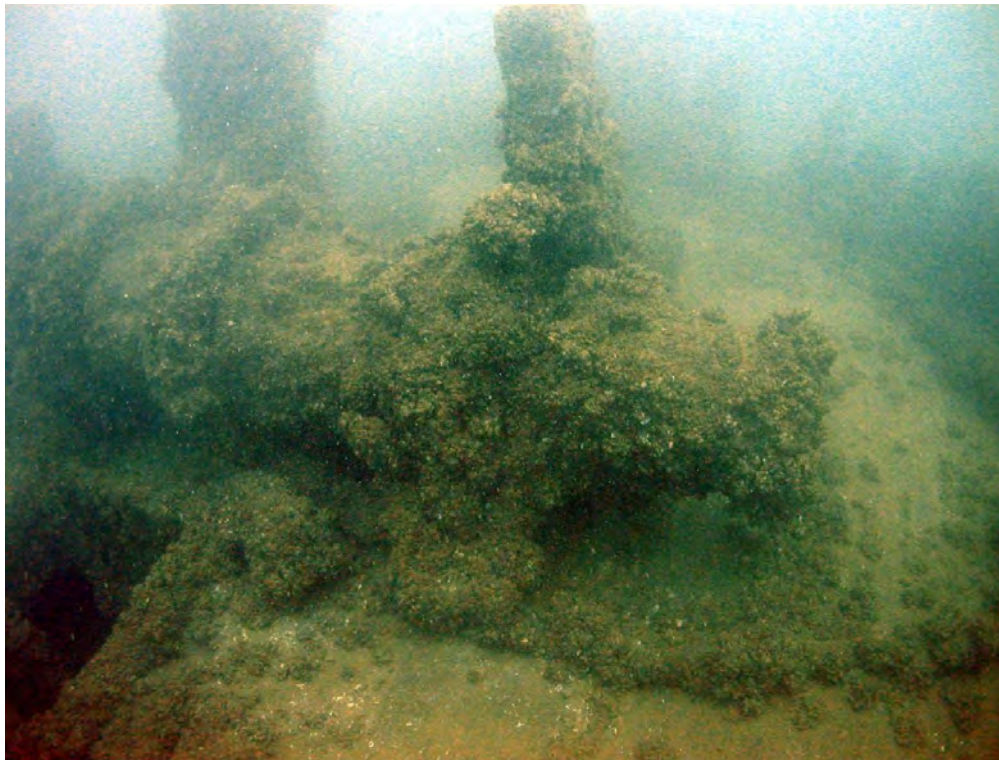

Figure 37 Windlass (Photo by David VanZandt, CLUE)

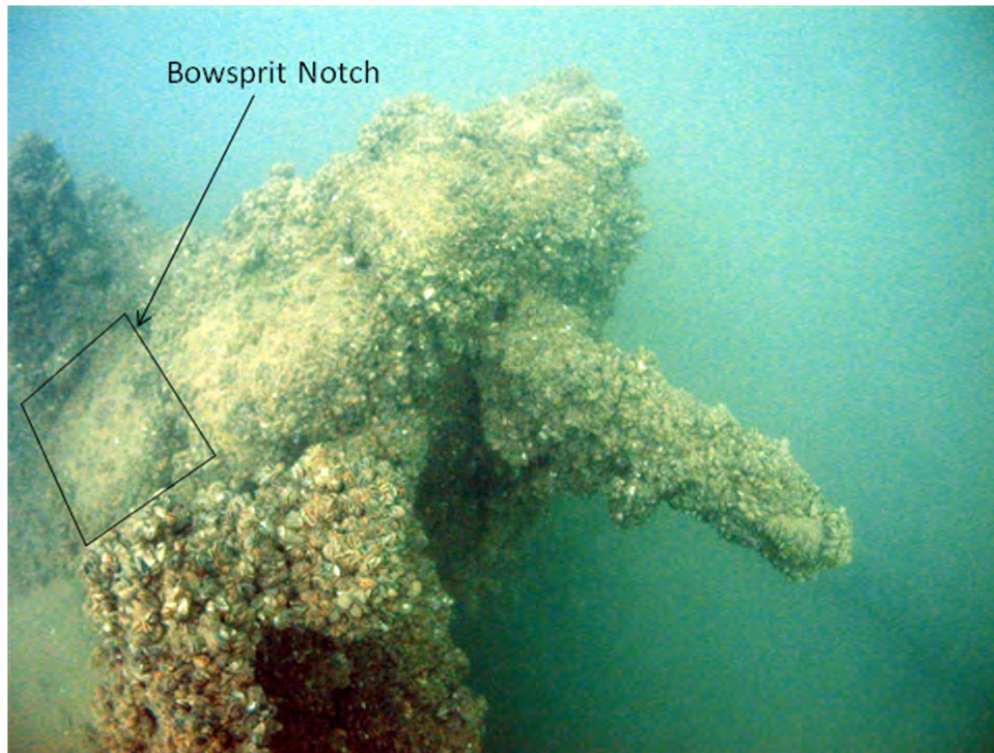

Figure 38 Bowsprit notch in bow (Photo by David VanZandt, CLUE)

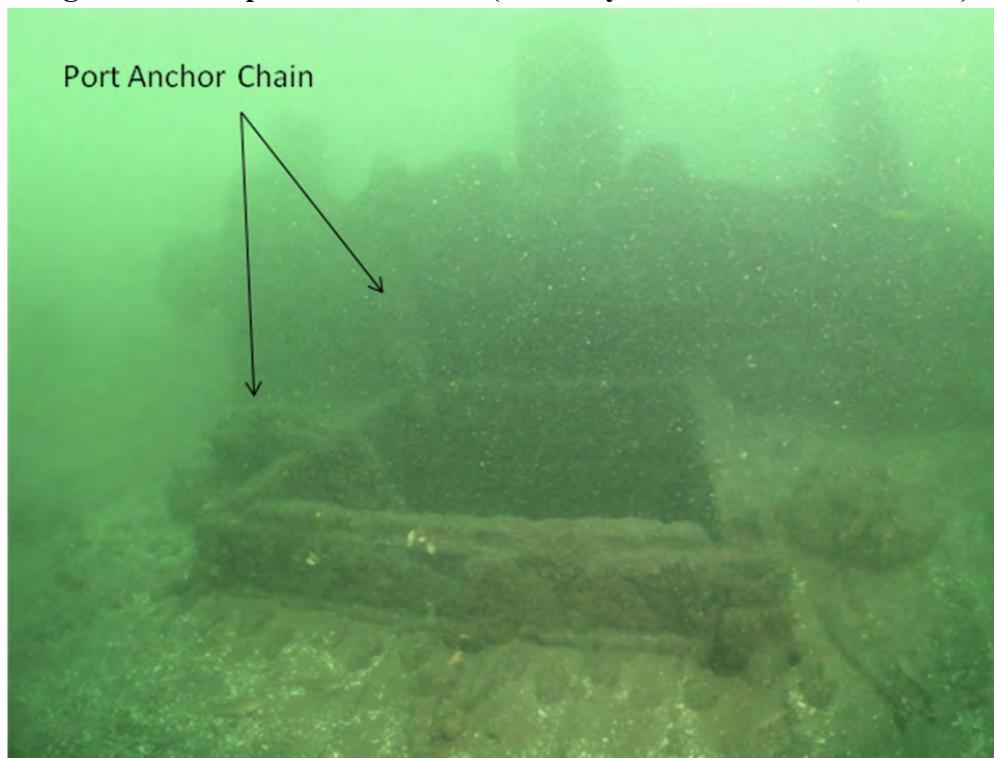

Figure 39 Port anchor chain running to windlass (Photo by David VanZandt, CLUE)



**Figure 40 Chain locker and broken anchor chain coming out of starboard spurling pipe
(Photo by David VanZandt, CLUE)**



**Figure 41 Anchor chain on deck starboard of the windlass (Photo by David VanZandt,
CLUE)**

Aft of the chain locker is a single-barrel hand pump (Figure 42) along with the remains of the foremast located just behind this pump and broken off at deck level (Figure 43). Along the railings adjacent to the foremast are the remains of six large deadeyes on each side. The deadeyes are no longer attached to the railings and their chainplates are bent down parallel to the hull suggesting the mast was violently wrested from the standing rigging (Figure 44). The large number of deadeyes is a good indicator that the foremast was square-rigged.



Figure 42 Single-barrel hand pump (Photo David VanZandt, CLUE)



Figure 43 Pump and foremast remains (Photo by David VanZandt, CLUE)



Figure 44 Chain plates and deadeyes (Photo by David VanZandt, CLUE)

The wreck has an obvious list of about 30 degrees to starboard. The railings on both the starboard (Figure 45) and port sides (Figure 46) are mostly intact. Round grindstones are piled up on the deck along the inboard starboard railing in stacks of one, two, or three stones high and in several rows (Figure 47). The grindstones start near the foremast and continue all the way to the stern (Figure 48). The larger stones, about 5.5 feet in diameter, are located forward, and the smaller stones, about 3.5 feet in diameter, are located toward the stern.



Figure 45 Intact starboard railing. (Photo by Jack Papes, Akron, Ohio)



Figure 46 Intact port railing. (Photo by David VanZandt, CLUE)

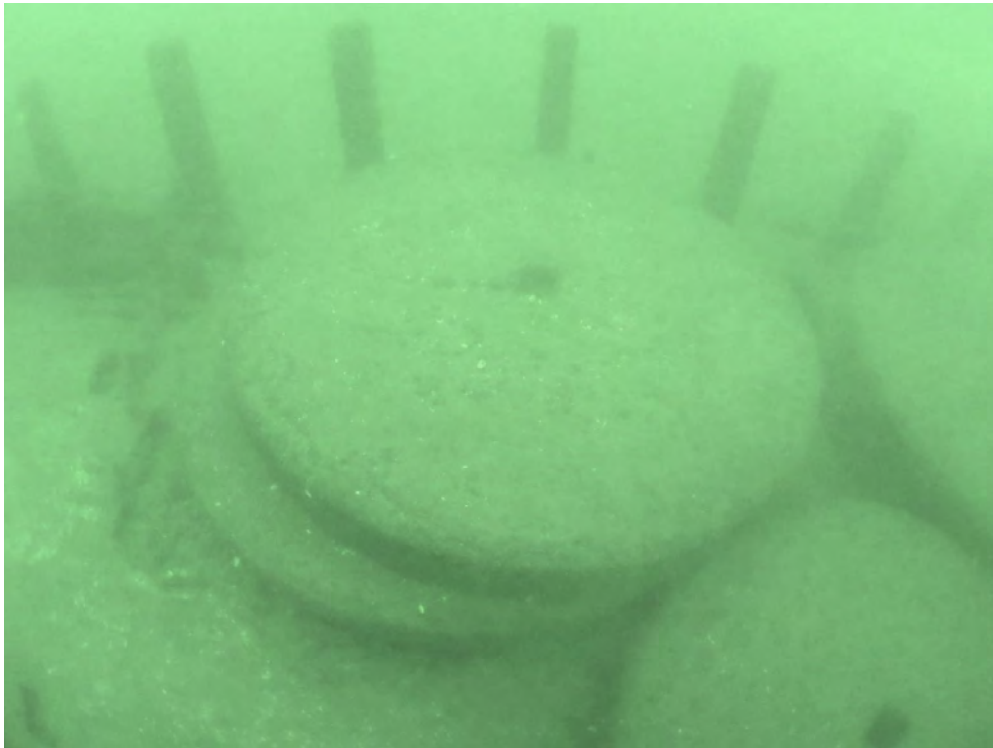

Figure 47 Grindstones along starboard side near bow (Photo by David VanZandt, CLUE)



Figure 48 Grindstones along starboard side (Photo by David VanZandt, CLUE)

Aft of the foremast stub is a cargo hatch. Two long boards protrude out from the after side of the hatch toward the starboard side and are likely remnants of the secondary cargo of lumber (Figure 49). Along the centerline of the vessel is a small slot in the deck followed by a small hatch aft of the slot (Figure 50) and another small slot (Figure 51). This is the location of the centerboard although no centerboard box is apparent inside the silt-filled hold as viewed through the center hatch and no centerboard winch is present at the aft slot but the two forward mounting holes for the winch appear to be on the deck



Figure 49 Forward cargo hatch (Photo David VanZandt, CLUE)



Figure 50 Small center hatch (Photo by David VanZandt, CLUE)



Figure 51 Aft center board slot (Photo by David VanZandt, CLUE)

A single large 5-foot diameter grindstone rests on the centerline wedged against a two-barreled wooden pump immediately behind the aft slot (Figure 52). The mainmast is missing but it stood behind this area as evidenced by the chainplates on the sides of the ship adjacent to this area. There are three deadeyes intended for each side. The deadeyes are missing on the starboard side railing (Figure 53) while two of the three deadeyes remain on the port side railing (Figure 54). A strip of missing centerline decking runs aft from the pump to another cargo hatch (Figure 55).



Figure 52 Two-barreled wooden pump and grindstone (Photo by David VanZandt, CLUE)



Figure 53 Dis-articulated deadeye on deck (Photo by David VanZandt, CLUE)



Figure 54 Attached deadeye (Photo by David VanZandt, CLUE)



Figure 55 Aft hatch (Photo by David VanZandt, CLUE)

Astern of the aft cargo hatch is a raised wooden combing that spans the entire beam and once formed the front of the now missing cabin (Figure 56). Grindstones are wedged against this combing and the starboard railing but do not spill into the cabin space (Figure 57). Four floor joists are present where the cabin floor was once located (Figure 58).



Figure 56 Aft cabin combing (Photo by David VanZandt, CLUE)



Figure 57 Grindstones piled up at cabin combing interface (Photo by David VanZandt, CLUE)



Figure 58 Cabin floor joist (Photo David VanZandt, CLUE)

The transom is missing, and the rudderpost, turned slightly to port, stands high off the bottom (Figure 59). The rudder cap, which would have been mounted on top of the rudderpost, can be seen lying inside the cabin on the port side (Figure 60). A line of grindstones that spilled from the boat as it drifted and sank is visible in the distance behind the stern running out across the bottom of the lake. The wreck's length and breadth were measured at 125 feet and 23 feet respectively which compares closely to the 127 feet by 24 feet indicated on the *Sultan's* various enrollments.



Figure 59 Rudder post (Photo by David VanZandt, CLUE)



Figure 60 Rudder post cap (Photo by David VanZandt, CLUE)

Portable Artifacts

Deck Hardware

The deck of the *Sultan* is strewn with a variety of dis-articulated deck hardware. Some of the hardware has been identified and some has yet to be. One of the most identifiable pieces of deck hardware to be found is the broken ship's wheel (Figure 61) located near the stern where the cabin once stood.



Figure 61 Broken ship's wheel (Photo by David VanZandt, CLUE)

Other deck hardware is depicted in the following figures:



Figure 62 Ships stove in aft cabin space (Jack Papes, Akron, Ohio)



Figure 63 Possible stove part (Photo by David VanZandt, CLUE)



Figure 64 Possible mechanical cross-head near the two-barreled pump (Photo by David VanZandt, CLUE)



Figure 65 Misc. deck hardware aft of main mast stub (Photo by David VanZandt, CLUE)



Figure 66 Misc. deck hardware (Photo by David VanZandt, CLUE)



Figure 67 Misc. chain and deck hardware, possible piece of the starboard cathead (Photo by David VanZandt, CLUE)



Figure 68 Double-pump mounting rings (Photo by David VanZandt, CLUE)



Figure 69 Metal clamp or vise (Photo by David VanZandt, CLUE)



Figure 70 Dis-articulated chain on deck (Photo by David VanZandt, CLUE)



Figure 71 Metal clamp located off of the bow (Photo by David VanZandt, CLUE)

Ceramics and Pottery

A quantity of ceramic items including a cup (Figure 72) and several plates manufactured by Anthony Shaw of Great Britain - as evidenced by the maker's mark - were found on the wreck. These marks date to the period of ca 1860-1882, consistent with the wrecking event (Thepotteries.org, 2014a). This tableware appears to be one of the designs manufactured by Shaw and distributed exclusively in the United States. It was likely stocked on the brig as part of its standard galley dishware during the *Sultan's* time in New York City from 1859-1861.



Figure 72 Anthony Shaw Cup (Photos by Chris Kraska, MAST)

A ceramic sherd was also discovered with a mark (Figure 73) that resembles the British diamond mark (Figure 74). During the period 1842-1883 the British Patent Office issued a diamond mark along with the registration number when a design was registered (Thepotteries.org, 2014b). This maker's mark is also consistent with the wrecking date and history of the *Sultan*.

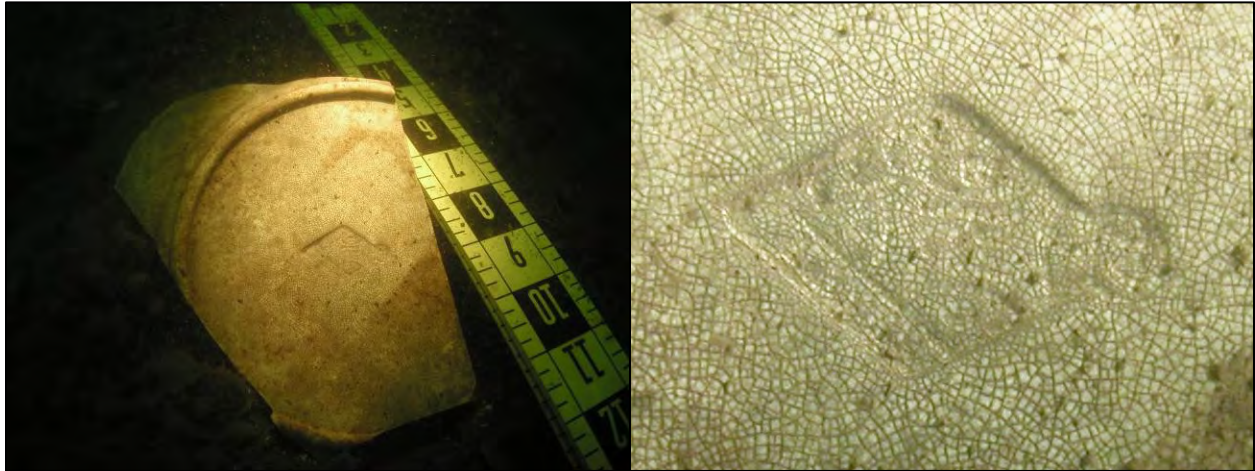

Figure 73 Ceramic sherd with presumed British diamond mark (Photos by David VanZandt, CLUE)



Figure 74 Representative British diamond mark (Thepotteries.org)

Additional ceramic, pottery, and glass items have been located on or around the wreck and a formal analysis of this assemblage will be performed at a later date (Figure 75, Figure 76).

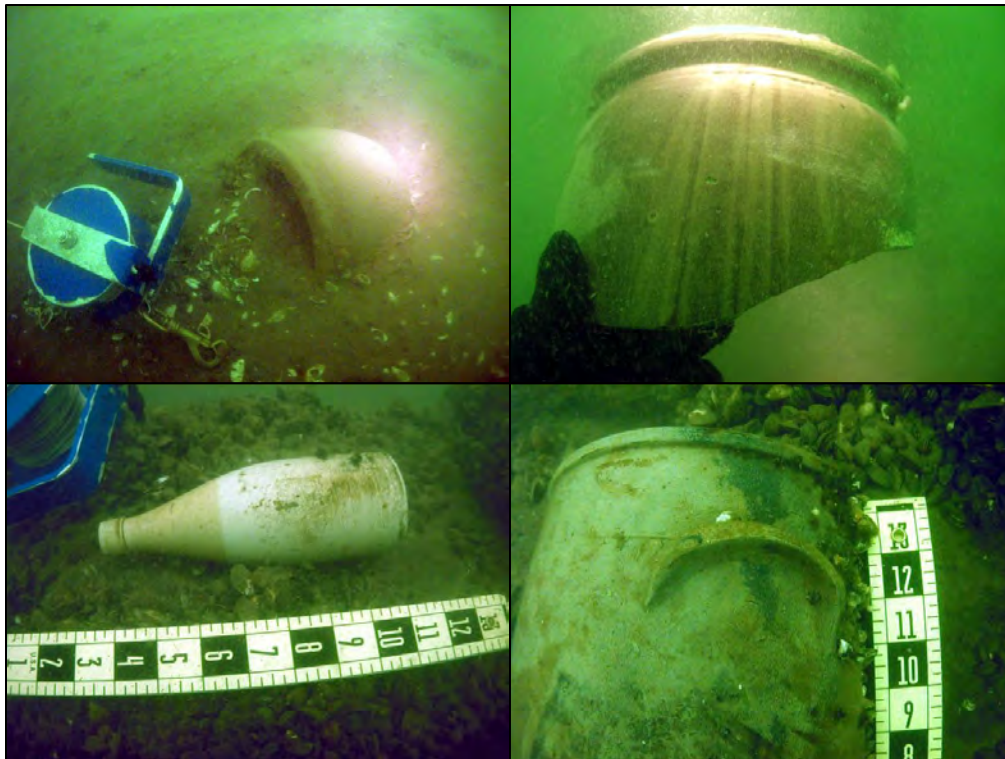

Figure 75 Various ceramics and pottery (Photos by David VanZandt, CLUE)



Figure 76 Various ceramics, pottery, and glass (Photos by David VanZandt, CLUE)

Survey Results

The survey data gathered by the divers was transferred from their wet survey sheets to dry survey sheets at the end of each dive (Figure 77). Initial post-processing of the survey data was performed using Site Recorder to determine the validity of the survey control point network and the validity of the survey data with respect to that network (Figure 78). Once the validity of the data was established, the remaining survey data, with the exception of the windlass, was post-processed and added to the master site plan. The windlass was drawn separately (Figure 79) and checked in Site Recorder before being added to the plan.

Sultan Survey Report

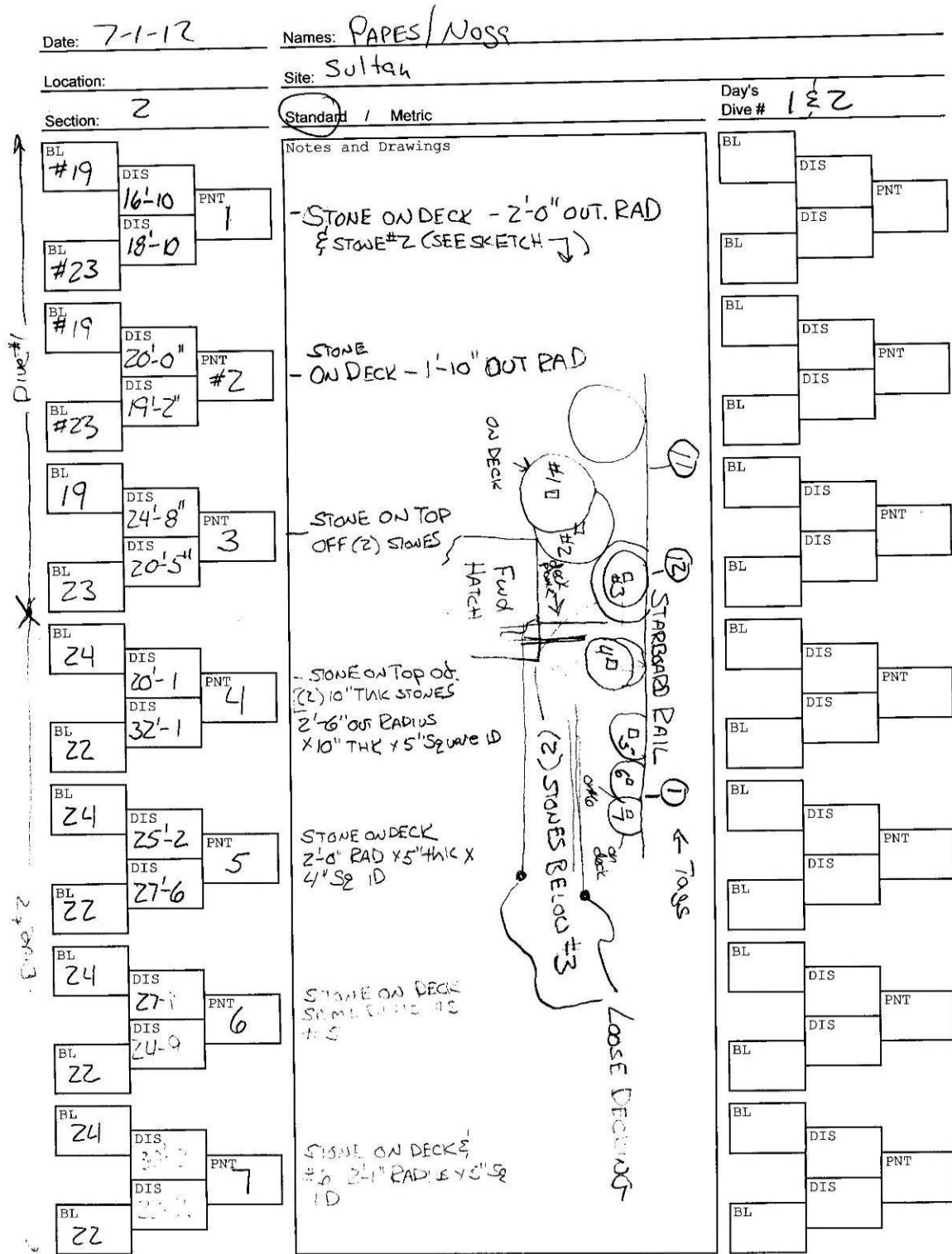

Figure 77 Example of filled in dry survey sheet (MAST)

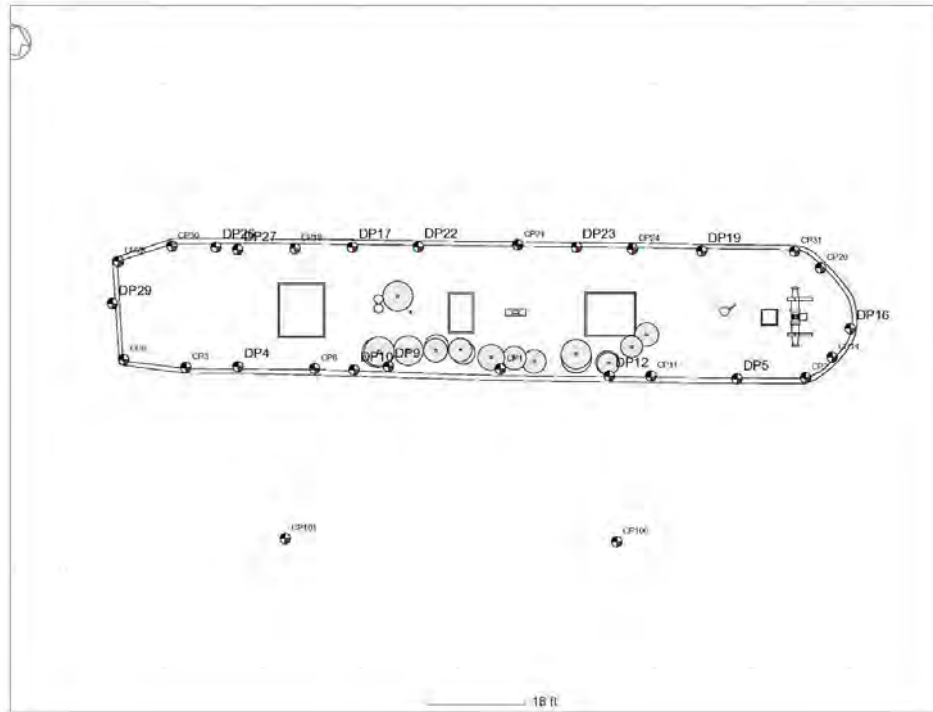
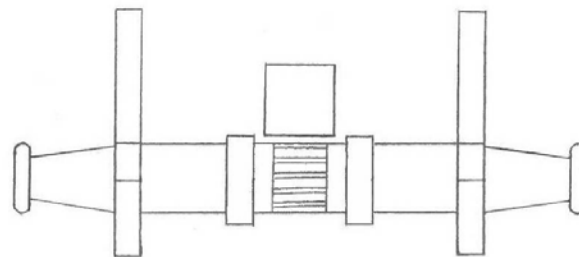
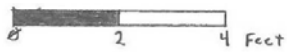

Figure 78 Site Recorder data validity check for early survey data from the *Sultan* (David VanZandt, CLUE)



Sultan windlass
1" = 2'
David M. VanZandt
2 Mar 2013

Figure 79 *Sultan* windlass (David VanZandt, CLUE)

Sultan Survey Report

The master site plan was drawn manually and converted to a digital format. The master site plan represents the accumulation of all the survey data collected to date and provides a detailed graphical representation of the *Sultan* wreck site as it appears today (Figure 80).

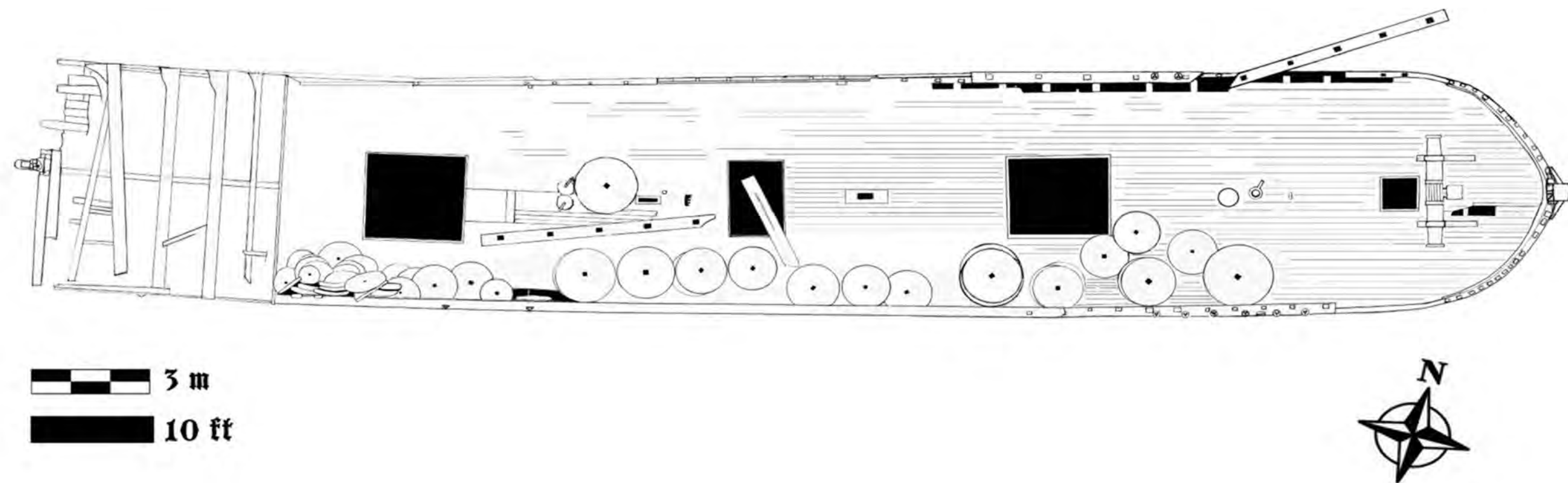

Figure 80 *Sultan* master site plan (Chris Kraska, MAST)

Post-Survey

Brian Abbott of Nautilus Marine Group International, LLC volunteered his expertise and 360 degree sonar equipment (post-survey) to produce detailed images of the wreck site. Brian and his colleague David Thompson travelled from Michigan with the equipment and joined project manager Chris Kraska, who provided and captained the boat, to create these high resolution scanning sonar images (Figure 81 and Figure 82).

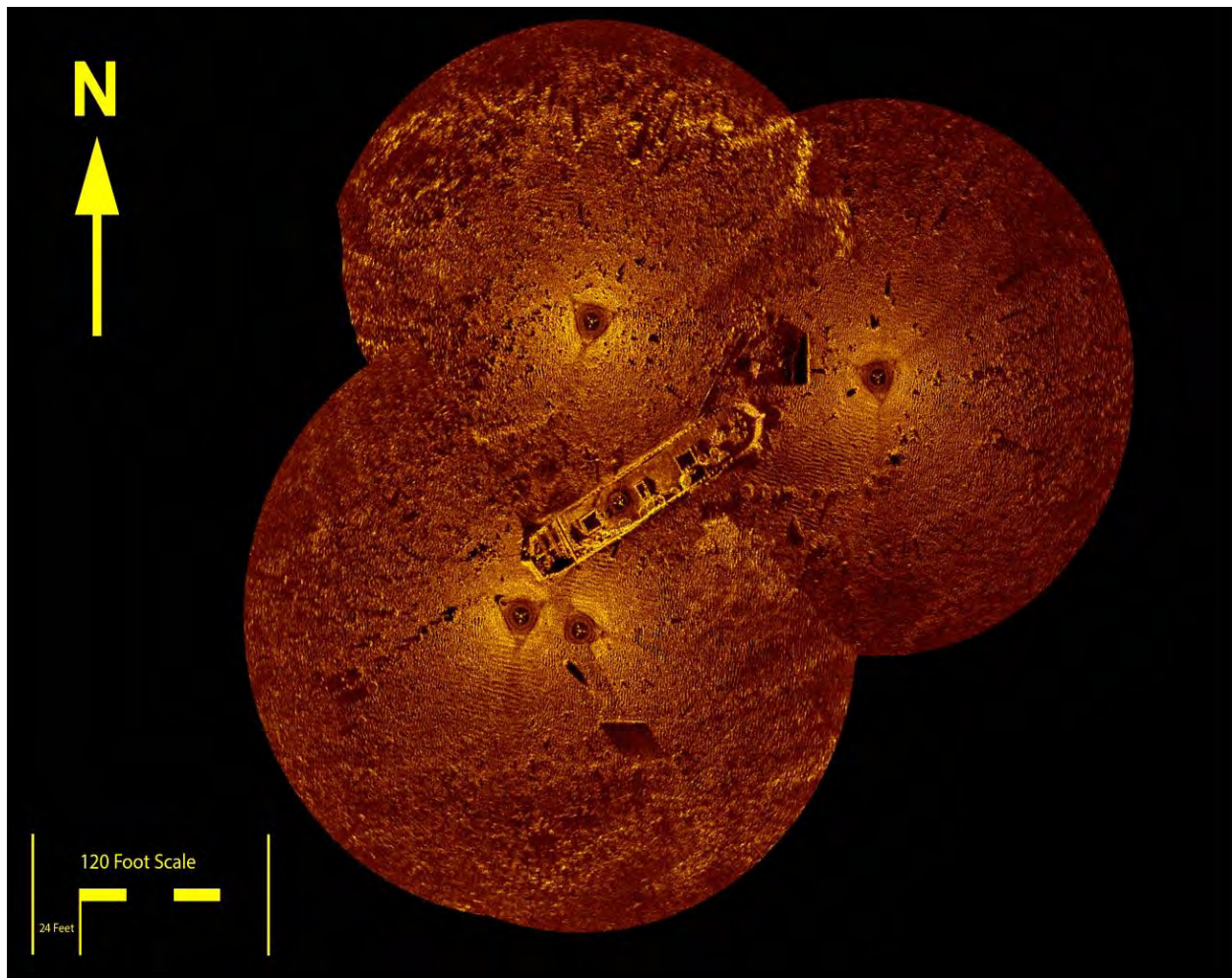

Figure 81 *Sultan* 360 Sonar 120 ft composite image. (Brian Abbott, Nautilus Marine Group International, LLC)

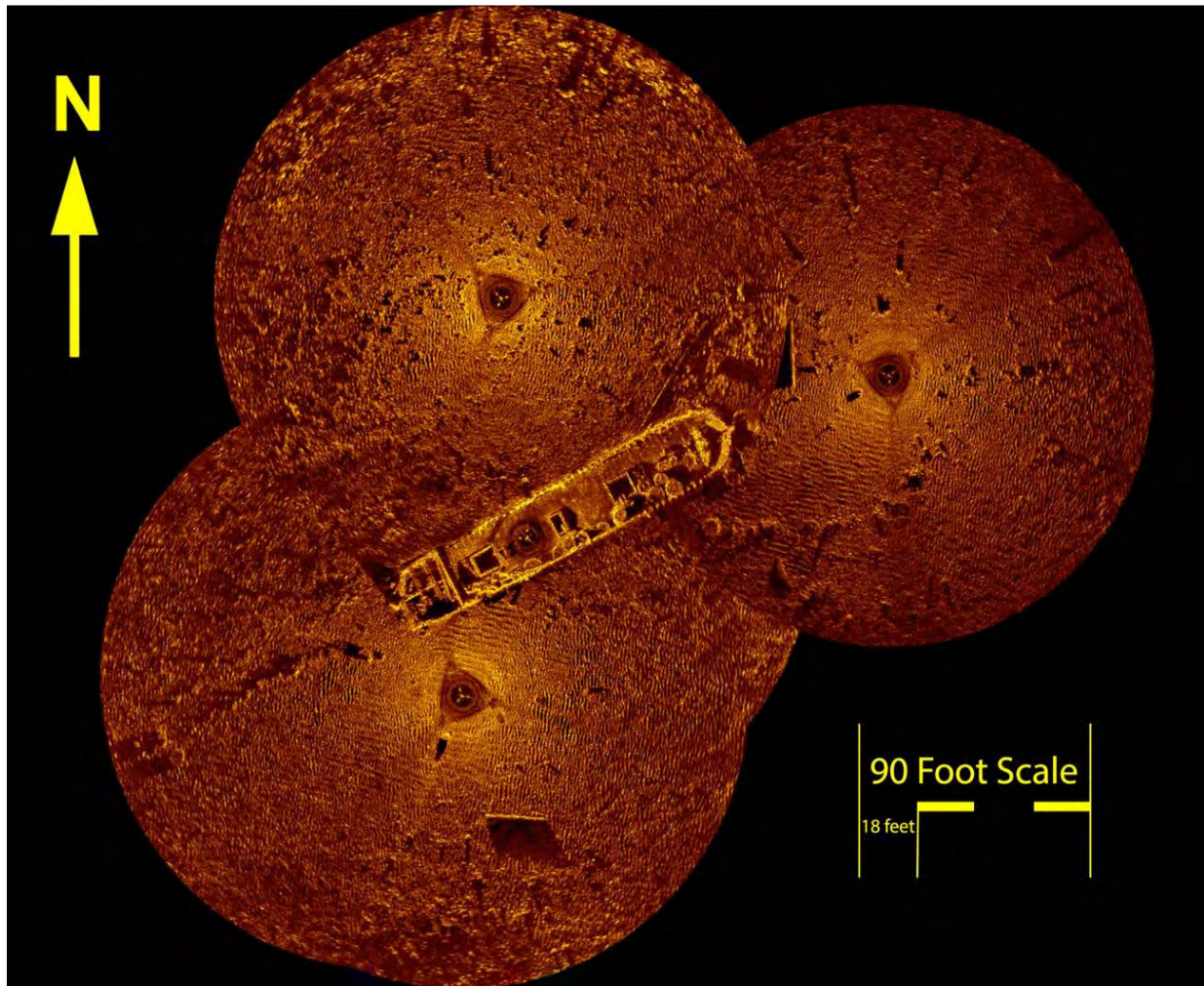

Figure 82 *Sultan* 360 Sonar 90 ft composite image. (Brian Abbott, Nautilus Marine Group International, LLC)

8) **Conclusions**

The authors have little doubt that the remains of the ship described herein are those of the sailing vessel, *Sultan* first registered in the District of Chicago in 1848. The vessel's history is well researched and it has proven to be quite interesting. During her 16 year history the *Sultan* sailed not only on the Great Lakes but also in the Atlantic and Caribbean. After several mishaps, refits, and changes of ownership she came to rest where she sits today, a mere two and a quarter miles offshore just East of Cleveland, Ohio.

Her identification is made using information from a number of sources. First, the archaeological data obtained from the survey is consistent with the time period in which the *Sultan* sank. This includes personal items, cookware, and tools found on site as well as the construction methods and materials used on the vessel. Second, the scantling data obtained from the survey is consistent with the as-built data obtained from the historical record. Finally, the historical accounts and records are also consistent with the disposition of the wreck and the remains of her cargo. All of these taken together provide a very strong case that the wreck is that of the brig *Sultan*.

In the near future the historical and survey data obtained during the course of the project will be used to create a dive slate for the *Sultan*. The dive slate will feature a site map, diving information, vessel data, and history. The slate will enhance the diving experience of both new and experienced divers who elect to visit and explore the remains of the brig *Sultan*.

9) **Acknowledgements**

On behalf of MAST and the entire *Sultan* Survey Project team, the authors would like to thank the Cleveland Underwater Explorers organization for its support and assistance with the *Sultan* project. They would also like to thank the Great Lakes Historical Society for its unwavering support over the years. Additionally, the authors would like to thank 3H Consulting Ltd. for providing its Site Recorder 4 survey software that was used to verify the control point network and help to verify some of the survey data used to develop the site plan for the wreck.

Sultan Mooring Project

The following departments/groups/individuals participated in the *Sultan* Mooring Project:

Non-Profits:

Cleveland Underwater Explorers, Inc. (CLUE): Located the *Sultan* and made its coordinates available.

Maritime Archeological Survey Team, Inc. (MAST): Secured approvals, funding, constructed, and maintains the mooring.

Great Lakes Historical Society (GLHS): General support of CLUE and MAST

Ohio Archaeological Council (OAC): Provided a grant for *Sultan* mooring project

Governmental:

Ohio Department of Natural Resources – Office of Coastal Management (ODNR-OCM): Letter of Consistency for site project.

Ohio Historical Society - Ohio Historic Preservation Office (OHPO): Section 106 review and letter of approval for anchor block/project.

US Army Corps of Engineers (USACE): Letter of Authorization (LoA) for anchor block.

US Coast Guard (USCG): Approved a Private Aids to Navigation permit for mooring.

Businesses/Clubs/Private:

Norwalk Concrete Industries, Inc. (NCCI): owner and MAST member Jeff Malcolm donated the 6000-lb. concrete anchor block and the delivery of the block to the boat.

Ohio Council of Skin and Scuba Divers (OCSSDI): Allowed CLUE/MAST presentation at ScubaFest, which lead to other contributions, plus their own contribution.

Just Add Water: Allowed CLUE/MAST presentation at their spring party, which lead to other contributions, plus their own contribution.

Bay Area Divers (BAD) have allowed CLUE and MAST to present at multiple club meetings. These presentations have lead to the largest single contribution towards the project. BAD also allows Mast to receive yearly funds to support the mooring project upkeep.

Contractors/Suppliers:

Underwater Marine Contractors (owner, Bart Schasfoort): He, his work boat, and his commercial diver(s) set the block at the *Sultan* (and all the wrecks). Compensated by MAST, but still a necessary part of the process.

Samsel Supply: All hardware for the moorings. Compensated, but necessary parts for buoy construction.

Other suppliers:

Rolyan Buoys, Carmanah strobes, Carolina Waterworks underwater floats, etc. Compensated by MAST.

Other:

Miscellaneous MAST members who have donated time, skills, materials to make mooring parts.

Sultan Survey Project

The following departments/groups/individuals participated in the *Sultan* Mooring Project:

Non-Profits:

Great Lakes Historical Society (GLHS)

Peachman Lake Erie Shipwreck Research Center (PLESRC)

Cleveland Underwater Explorers, Inc. (CLUE)

Maritime Archeological Survey Team, Inc. (MAST)

Contractors:

Trident Marine

Nautilus Marine Group International, LLC (Donated time, expertise and use of equipment.)

Individuals:

Abbott, Brian

Andree, Don

Balas, George

Baron, Lori

Bittenbender, Nick

Bratton, Wayne

Brown, Connie

Brown, Tim

Burden, Don

Chrisopulous, Mike

Clover, Judd

Cullinan, Nate

Cullinan, Tim

Sultan Survey Report

Cullinan, Tyler

Day, Grant

Deegan, Paul

Dodds, Harry

Dodds, Margaret

Duff, Vivian

DeMont, Gary

Edelbrock, Eric

Enlow, Patrick

Facsina, Stephen

Fisher, Glen

Frazer, Tony

Frodl, Vince

Goodrich, Chris

Haas, Mallory

Hagen, George

Herbruck, Chris

Kauffman, Kira

Kraska, Chris

Lardner, Joe

LaRosa, Cindy

Magee, Kevin

Marchand, Keith

Marshall, Ken

Sultan Survey Report

Matyac, Eric

McGee, Neil

Noga, Ed

Novak, Barb

Pansing, Linda

Pansing, Scott

Papes, Jack

Paskert, Jim

Pate, Francine

Sasala, Robert

Searles, Chase

Shepard, Laurel

Sowden, Carrie

Szabo, Tom

Thompson, David

Toth, John

VanZandt, David M.

Winterringer, Becca

Yates, Aaron

10) About the Authors

David M. VanZandt, MMA RPA:

Director and Chief Archaeologist of the Cleveland Underwater Explorers, Inc. (CLUE) and MAST member; David is the Senior Principal Engineer for ZIN Technologies, Inc., specializing in space flight hardware for NASA Glenn Research Center and has more than twenty five years of experience designing, building, testing, and operating fluids and combustion experiments on the Space Shuttle, sounding rockets, and International Space Station.

David began his diving career in 1995 and currently holds dive certifications up through trimix and AIMA/NAS Level 3. He began searching for and finding shipwrecks off his boat Sea Dragon in 2001 when he founded the Cleveland Underwater Explorers (CLUE). David graduated Purdue University in 1981 with a Bachelor of Science in Nuclear Engineering. He is also a graduate of Flinders University and holds several archaeology degrees including a Masters of Maritime Archaeology. David is on the Register of Professional Archaeologists (RPA) and is a member of the Ohio Archaeological Council (OAC), the Association of Great Lakes Maritime History (AGLMH), the Great Lakes Historical Society (GLHS), and the Society for Historical Archaeology (SHA). He is also a fellow in The Explorers Club.

Jim Paskert:

Director of Archival Research for the Cleveland Underwater Explorers (CLUE) and MAST member; Jim is a Production Planner for ZIN Technologies, Inc. He learned to dive in 1966 and began researching Great Lakes shipwrecks, ultimately making his first discovery, the steamer Sand Merchant, in 1969.

Jim has been researching and discovering shipwrecks in the Great Lakes ever since. For over 40 years he has been involved with locating the majority of the shipwrecks in the Cleveland, Ohio, area of Lake Erie. An accomplished researcher, Jim has assembled a massive library on Great Lakes maritime history. Specializing in primary sources for his information, his

collection includes data not commonly found in traditional shipwreck research. His resume includes a long list of diving, shipwreck finds, and related accomplishments.

Kevin Magee:

Deputy Director of the Cleveland Underwater Explorers (CLUE) and MAST member; Kevin is the co-founder of CLUE and was certified for scuba in 1984. He moved to the Cleveland, OH, area in 1993 and discovered shipwreck diving in the Great Lakes shortly afterwards. He enthusiastically practices diving shipwrecks in Lake Erie as well as the other Great Lakes. He was trimix certified in 1999 and has visited many of the pristine deep water wrecks that technical diving allows.

Kevin has a Bachelor of Science in Mechanical Engineering and a Masters of Science in Mechanical and Aerospace Engineering. He is a Senior Mechanical Engineer for ZIN Technologies, Inc., and is a contract engineer at the NASA Glenn Research Center. Kevin designs, builds, tests, and operates fluids and combustion experiments for the Space Shuttle, sounding rockets, and International Space Station. Kevin is a member of the Great Lakes Historical Society (GLHS) and several local scuba clubs. He also maintains his own web site on diving Great Lakes shipwrecks.

Chris Kraska:

Chris Kraska has an undergraduate degree in political science/history, a masters degree in education, and is completing a degree in anthropology with an archaeology focus. He has taught school in the Cleveland Metropolitan School District for 16 years. Previously he worked in public and media relations for several large non-profit organizations in South Florida.

Chris coordinated local and national media coverage for not-for-profit organizations following the devastation of Hurricane Andrew in 1992. He worked as media relations director for the American Red Cross Blood Services for Palm Beach, Miami Dade, and Monroe counties in the mid 1990s.

Chris' foray into diving is fairly recent with his initial open water certification in 2006. Since that time he has achieved certification as a divemaster (2009) and works part time in that capacity. Chris has been involved in MAST since taking the organization's spring workshop in 2006. He has been on the Board of Directors for MAST since 2010 and has served as the chairman since 2012.

In addition to his involvement in MAST Chris is a member of the Great Lakes Historical Society and the Shipwreck Expeditions Association. He was a team member of the latter's 2014 expedition which was responsible for locating and identifying the wreck of the Polish escort destroyer ORP Kujawiak, designated L72, which sank during Operation Harpoon off of Malta in June of 1942. Chris' father was a sailor onboard the Kujawiak and survived her sinking.

Ken Marshall:

Ken is a Senior Consulting Engineer for Engineering Design & Testing Corp., specializing in forensic engineering conducting root cause investigations and damage analysis. He has over 25 years of experience in the design, fabrication, assembly, operation, and maintenance of custom industrial equipment. Ken graduated from the University of Cincinnati in 1985 with a Bachelor of Science in Mechanical Engineering. He also earned a Master in Business Administration from Cleveland State University. Ken is a licensed Professional Engineer (P.E.) in 14 states.

Ken began his diving career in 1979 and has obtained the rating of O/W Instructor. In addition he holds certifications in numerous specialties including gas blending, tri-mix, SCR rebreather, and cave. Ken's interest in shipwrecks expanded in 1999 after taking the GLHS/MAST Nautical Archaeology for Divers Workshop, eventually earning Underwater Archaeology Instructor certification.

Ken is a past chair of the MAST Board and manages the MAST Historic Shipwreck Mooring Program. He continues to be a member of the Great Lakes Historical Society (GLHS), the Maritime Archaeological Survey Team (MAST), and the Cleveland Underwater Explorers (CLUE).

Linda Pansing:

Curator of Archaeology, Ohio Historical Society and MAST member: As Curator Linda is responsible for the creation and upkeep of department databases and records, performs cataloging and other collection care and research duties. In the course of her work she has had the opportunity to conduct investigations at several Society holdings including Pickawillany; Fort Ancient; U.S. Grant Boyhood Home, School House and Birthplace; John Rankin House; Miamisburg Mound; Fort Meigs; Flint Ridge; Newark Earthworks; Leo Petroglyph; Harrison Tomb; Quaker Meeting House; Zoar; Paul Laurence Dunbar House; and the Ohio River Museum.

Linda is an avid scuba diver and has managed to mesh her passion for archaeology with diving right here in Ohio. She is a founding member, and past board member of the Maritime Archaeological Survey Team (MAST), a 501(c)(3) non-profit dedicated to the documentation of Ohio's underwater cultural resources, otherwise known as shipwrecks. Efforts of MAST have resulted in the instruction of hundreds of scuba divers from Ohio, surrounding states and Canada on underwater survey techniques; Ohio, national and international shipwreck law, research and report writing. The outcomes have been the listing of shipwrecks as Ohio archaeological sites with the State Historic Preservation Office, project reports, and Ohio's first underwater dive slates (maps) of shipwrecks.

In addition to MAST, Linda's other memberships include the American Anthropological Association, Association for Great Lakes History, Midwest Archaeological Conference, National Speleological Society, Ohio Archaeological Council, Ohio Council of Skin and Scuba Divers, Save Ontario Shipwrecks, Society of American Anthropologists, Society for Historical Archaeology and several Ohio dive clubs.

11) **About M.A.S.T.**

MAST is a nonprofit avocational group dedicated to the documentation of Ohio's underwater historic resources and is composed of volunteer individuals who support and participate in research, documentation, underwater archaeological surveys, and educational workshops. MAST's ongoing commitment to education includes training new members on skills and techniques used for shipwrecks research, measuring, mapping, and plotting. The *Sultan* underwater archaeological survey provided a real world environment in which members could apply the training that they had received. It also provided valuable experience in how to deal with the realities of underwater work in challenging and changing worksite conditions – experience that cannot be obtained in a class room setting

12) References

Andreas, A. T.

1884 History of Chicago, Vol 1. A. T. Andreas, Chicago.

Carter, Williams, Fueller, Meisburger

1982 Regional Geology of the Southern Lake Erie (Ohio) Bottom: A Seismic Reflection and Vibracore Study, Miscellaneous Report No. 82-15. U.S. Army Corp of Engineers, Coastal Engineering Research Center, Ft. Belvoir, VA.

The Cleveland Herald

1864 Terrible Disaster. *The Cleveland Herald* September 26:3. Cleveland, Ohio

The Cleveland Leader

1864 Terrible Disaster on the Lake. *The Cleveland Leader* September 26:4. Cleveland, Ohio

Dames and Moore

1974 Airport Feasibility Study for the Lake Erie Regional Transportation Authority, Phase I, Report No. 5-1 and 5-2, Dames and Moore, Los Angeles.

Dibble, C. B.

1864 Orders, Correspondence, &c., &c., Relating to the Expulsion of C. B. Dibble from the Department of North Carolina. Press of Wynkoop, Hallenbeck & Thomas, New York.

District of Buffalo

1858, Enrollment No. 26, 26 April 1858, Records of the Bureau of Marine Inspection and Navigation, Record Group 41, National Archives, Washington, DC.

1859, Enrollment No. 17, 19 December 1859, Records of the Bureau of Marine Inspection and Navigation, Record Group 41, National Archives, Washington, DC.

Sultan Survey Report

District of Chicago

1847, Enrollment No. 1, 19 April 1847, Records of the Bureau of Marine Inspection and Navigation, Record Group 41, National Archives, Washington, DC

1848a, Enrollment No. 40, 27 July 1848, Records of the Bureau of Marine Inspection and Navigation, Record Group 41, National Archives, Washington, DC.

1848b, Enrollment No. 75, 26 October 1848, Records of the Bureau of Marine Inspection and Navigation, Record Group 41, National Archives, Washington, DC.

District of Cuyahoga

1862, Enrollment No. 62, 25 June 1862, Records of the Bureau of Marine Inspection and Navigation, Record Group 41, National Archives, Washington, DC.

Mansfield, J. B.

1899 History of the Great Lakes, Vol. 1. J. H. Beers Co., Chicago

Maritime History of the Great Lakes

2013a *Sultan* (Brig), aground, 11 Nov 1853. <http://images.maritimehistoryofthegreatlakes.ca/40078/data?n=3>. Accessed 4 February 2013.

2013b, *Sultan* (Brig), 1 Sep 1853.
<http://images.maritimehistoryofthegreatlakes.ca/30704/data?n=1>. Accessed 4 February 2013.

2013c, *Sultan* (Brig), capsized, 10 Jun 1853.
<http://images.maritimehistoryofthegreatlakes.ca/39860/data?n=2>. Accessed 4

Sultan Survey Report

February 2013.

2013d, *Sultan* (Brig), aground, 4 Nov 1856.

<http://images.maritimehistoryofthegreatlakes.ca/40555/data?n=4>. Accessed 4 February 2013.

Marine Review

1901, Pleasing incident aboard the Erie, 6 June 1910:17, Penton Press, Cleveland.

The New York Times

1860a, Marine Intelligence, *The New York Times*, 27 August 1860:8, New York.

1860b, Marine Intelligence, *The New York Times*, 20 September 1860:8, New York.

1860c, Marine Intelligence, *The New York Times*, 6 November 1860:8, New York.

1861a, Marine Intelligence, *The New York Times*, 17 June 1861:8, New York.

1861b, Marine Intelligence, *The New York Times*, 12 September 1861:8, New York.

1861c, Marine Intelligence, *The New York Times*, 7 October 1861:8, New York.

Michigan Sea Grant

2014 Michigan Sea Grant

<http://www.miseagrant.umich.edu/explore/about-the-great-lakes/>. Accessed 8 May 2014

NOAA

2014a Great Lakes Environmental Research Laboratory

<http://www.glerl.noaa.gov/pr/ourlakes/lakes.html>. Accessed 8 May 2014

Sultan Survey Report

2014b Great Lakes Environmental Research Laboratory

<http://www.glerl.noaa.gov/pubs/brochures/foodweb/LEfoodweb.pdf>. Accessed 8 May 2014

2014c National Geophysical Data Center

<http://www.ngdc.noaa.gov/mgg/greatlakes/erie.html>. Accessed 8 May 2014

2014d National Geophysical Data Center

http://www.ngdc.noaa.gov/mgg/greatlakes/lakeerie_cdrom/html/e_gmorph.htm. Accessed 8 May 2014

Ohio Revised Code

1992 Ohio Revised Code sections 1506.30-1506.99.

<http://codes.ohio.gov/orc/>. Accessed 28 Apr 2013.

Peachman Lake Erie Shipwreck Research Center of The Great Lakes Historical Society

2004 'Divers, Shipwrecks and Ohio Law', Pamphlet, Vermillion, Ohio

The Plain Dealer

1864 Terrible Lake Disaster. *The Plain Dealer* September 26:3. Cleveland, Ohio

Thepotteries.org

2014a North Staffordshire Pottery Marks, Anthony Shaw

http://thepotteries.org/mark/s/shaw_a.html. Accessed 29 April 2014

2014b Registration Diamonds & Numbers

<http://www.thepotteries.org/mark/reg.htm>. Accessed 29 April 2014

U.S. Code

1987 43 U.S. Code Chapter 39 - ABANDONED SHIPWRECKS

Sultan Survey Report

<http://uscode.house.gov/view.xhtml?path=/prelim@title43/chapter39&edition=prelim>, Accessed 28 April 2014

USGS

2014a United States Geological Survey, Zebra Mussels

http://fl.biology.usgs.gov/Nonindigenous_Species/Zebra_mussel_FAQs/Dreissena_FAQs/dreissena_faqs.html. Accessed 19 May 2014

2014b United States Geological Survey, Goby's Fact Sheet

<http://nas.er.usgs.gov/queries/FactSheet.aspx?SpeciesID=713>. Accessed 19 May 2014

VanZandt, David M.

2009 'A Systematic Method for the Identification of Historic Era Shipwrecks', Master's thesis, Department of Archaeology, Flinders University, Adelaide, South Australia.

Waterkeeper

2014 Lake Erie Waterkeeper

<http://www.lakeeriewaterkeeper.org/lake-erie/facts/>. Accessed 8 May 2014